

ALTRONIC®, INC.
712 TRUMBULL AVENUE
GIRARD, OHIO 44420

DIGITAL SPEED SWITCHES DO-3300, DO-3300A INSTALLATION INSTRUCTIONS ADO II 5-86

<p>WARNING: Read these instructions carefully before installing or operating the DO device. An improperly installed or operating device may result in an unsafe operating condition of the monitored machine which consequently could pose the threat of personal injury to operators or other nearby personnel.</p>

1.0 DESCRIPTION

- 1.1 The Altronic DO-3300 and DO-3300A speed switches are solid state units operating directly from capacitor discharge ignition systems. They require no other power source. The speed switch consists of a digital counting circuit activating a solid state switch. The counter operates on a 0.25 - 0.38 second time base for fast reaction to an overspeed condition. The ignition input voltage must be 100V. peak or higher at the trip point for proper operation.
- 1.2 There are two basic models available:
- Model DO-3300 is a general purpose speed switch with an isolated output switch rated at 400 VDC. It may be used for engine overspeed if connected to a latching output device or for other speed switch applications. The output switch turns on when the setpoint is exceeded and off when the speed drops 20 RPM below the setpoint (built-in hysteresis of 20 RPM).
 - Model DO-3300A is an engine overspeed device for use with ignition systems with a primary voltage of 200 VDC or lower. The output switch latches for 20-30 seconds when an overspeed occurs, then automatically resets. After an overspeed occurrence, wait at least 30 seconds before attempting to re-start the engine.
- 1.3 For reliable operation, the following instructions must be adhered to strictly.

2.0 SETTING FOR OPERATION ON ENGINE

- 2.1 SETPOINT SELECTOR SWITCHES - The speed setpoint is set with three (3) rotary switches in 10 RPM increments. For example, if the desired trip point is 1320 RPM, set the rotary switches as follows:

1	3	2	0
X1000	X100	X10	

Use a small screwdriver to set the white arrows at the desired numbers.

2.2 **ROCKER SELECTION SWITCHES** - The 7-position rocker switches set the unit for the proper ignition input frequency. The chart below gives the rocker selector settings for the various engine types. Only the switch positions listed should be switched to the ON position; all others must remain in the OFF position. Be sure the rocker switches are fully snapped into position (either ON or OFF). Reinstall the plastic cover over the rocker switches.

NO. OF CYLINDERS*		ROCKER SWITCHES ON
2-CYCLE	4-CYCLE	
1	1 OR 2	2,7
-	3	1,7
2	4	2,6
-	5	3,6
3	6	1,6
4	8	2,5
5	10	3,5
6	12	1,5
8	-	2,4
10	-	3,4
12	-	1,4

*Number of cylinders fired by the storage-discharge capacitor to which the DO device is connected. If two storage capacitors are used in the ignition system, the DO device sees only half the actual number of engine cylinders and must be set accordingly.

3.0 MOUNTING

3.1 Mount the speed switch securely with four (4) screws. For outdoor installations, enclose the device within the engine panel to avoid direct exposure to weather. Operating temperature range is -40°F. to +200°F.

4.0 WIRING (SEE WIRING DIAGRAMS)

4.1 **IGNITION POWER WIRING** - Connect the ignition shutdown lead as shown in the Wiring Diagrams. Observe the proper polarity as indicated on the device and in the listing below. The ground polarity terminal should be connected to the panel ground which should be the same as engine ground. **DO NOT GROUND** this device directly to the ignition system common coil ground.

NOTE: Use the 24 AWG wire provided with the device to make the power connections to terminals A and B or A and C.

4.2 IGNITION POWER WIRING HOOK-UP CHART

<p>THESE SYSTEMS ARE NEGATIVE GROUND. CONNECT GROUND TO "A" TERMINAL; CONNECT SHUTDOWN LEAD TO TERMINAL SHOWN BELOW:</p> <p>*Altronic I,I-6,I-D "B" TERMINAL *Altronic III "B" TERMINAL *Altronic V "B" TERMINAL Bendix BLAR "C" TERMINAL Bendix S1800,S1850 "C" TERMINAL Bendix SS "C" TERMINAL F-M 3000 "C" TERMINAL F-M 9000 "C" TERMINAL *U.T. Mag-tronic "B" TERMINAL</p>	<p>THESE SYSTEMS ARE POSITIVE GROUND. CONNECT SHUTDOWN LEAD TO "A" TERMINAL; CONNECT GROUND TO TERMINAL SHOWN BELOW:</p> <p>Altronic II "C" TERMINAL *F-M SCSA "B" TERMINAL</p>
---	--

*ONLY these systems may be used with model DO-3300A.
All listed systems may be used with model DO-3300.

4.3 SPEED SWITCH WIRING - A speed in excess of the setpoint actuates a normally open, solid state switch in the DO device.

A. DO-3300: The Output Switch (400 VDC rating) is accessible through terminals "D" and "E" and is isolated from ground and all other terminals. The Output Switch turns ON when the setpoint is exceeded and OFF when the speed is lowered 20 RPM below the setpoint (built-in hysteresis of 20 RPM). Maximum continuous current through the switch is 0.15 amp. A trip capacitor (not included) may be connected between terminals "F" and "E" as shown in the wiring diagrams.

B. DO-3300A: The Output Switch (200 VDC rating) is accessible through terminals "D" and "A". It is NOT isolated from the rest of the device circuitry. In this model, the Output Switch latches ON once tripped and remains on for approximately 20-30 seconds after the engine stops (ignition power ceases), then automatically turns OFF. A trip capacitor is built into the device which can be used to directly trip a Murphy tattletale switch, fuel valve or pneumatic valve as shown in the wiring diagrams.

4.4 CLASS I, GROUP D OPERATION (MODEL DO-3300 ONLY) - The DO-3300 device is CSA certified for Class I, Group D, Division 2 areas if mounted in a suitable panel or other suitable enclosure. If intrinsically safe operation (Class I, Group D, Division 1) is required, follow these additional steps:

1. Power the DO-3300 device from Altronic barrier 690 107 or 690 108; follow the hook-up instructions supplied with the barrier.
2. The output of the DO-3300 must be connected to Altronic DA annunciator system (usually sensor input no. 40).
3. All intrinsically safe wiring must be kept at least two (2) inches away from other, non-intrinsically safe wiring. See NFPA standard No. 493 for details.

WIRING DIAGRAMS - DO-3300

NEGATIVE GROUND IGNITION - MURPHY TATTLETALE

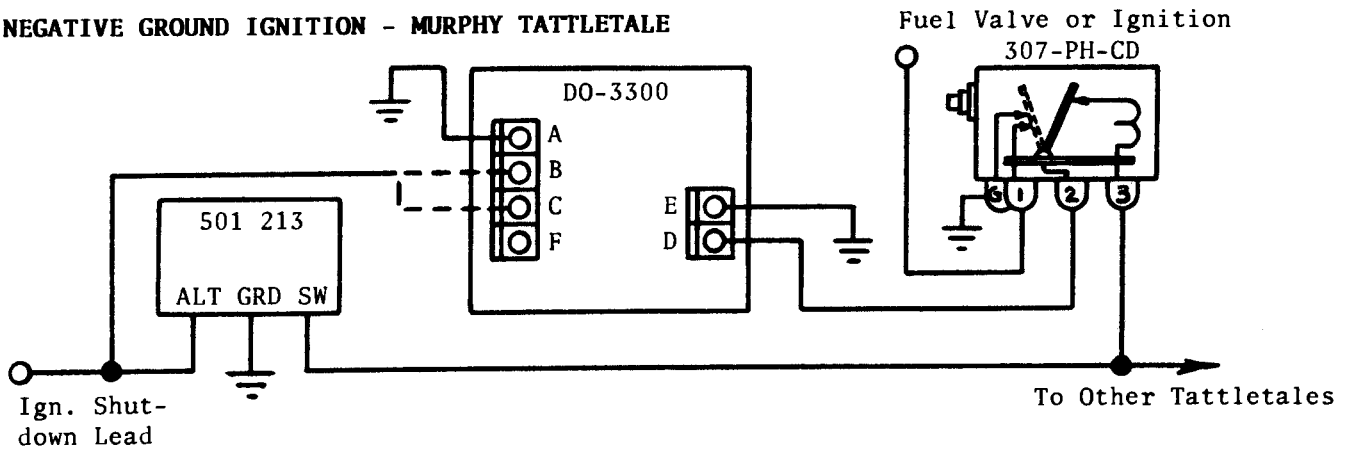

POSITIVE GROUND IGNITION - MURPHY TATTLETALE

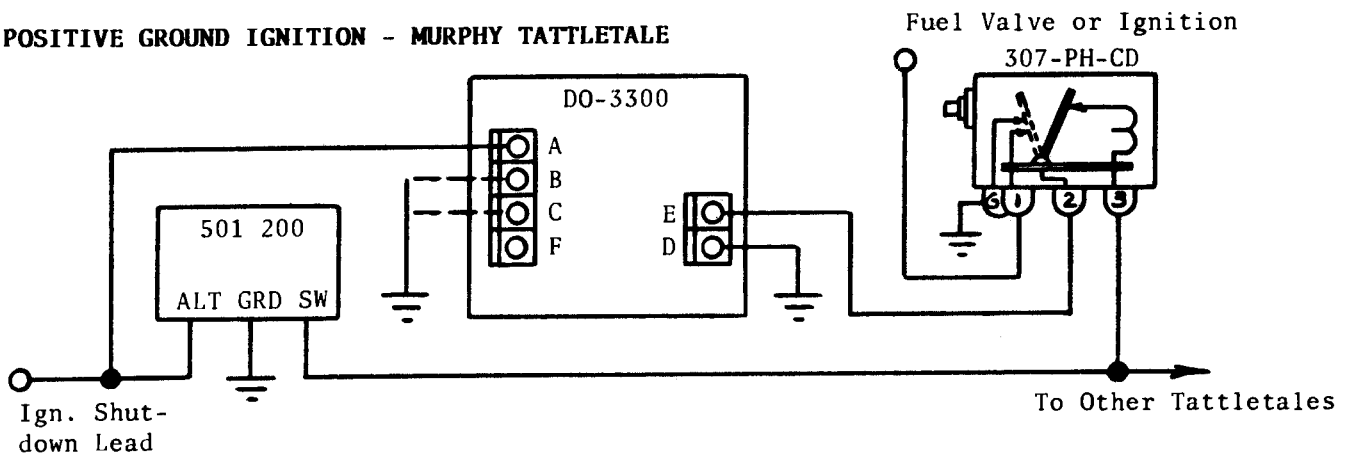

ALTRONIC DA/DC ANNUNCIATOR SYSTEM

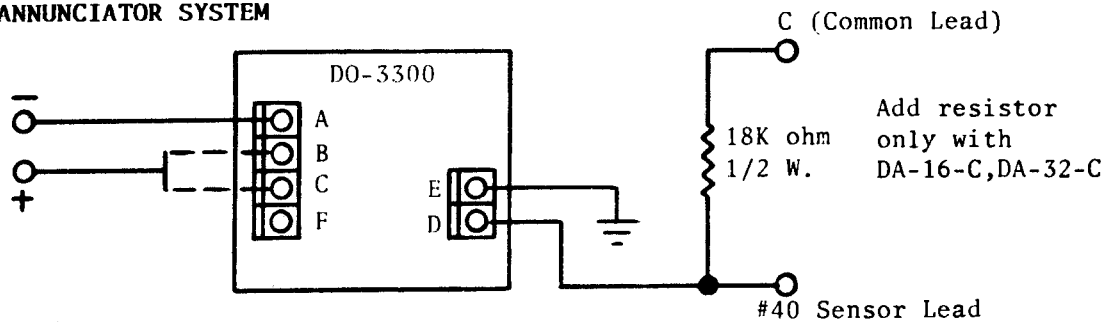

WIRING DIAGRAMS - DO-3300

12-24 VDC CONTROL SYSTEM (NON-LATCHING OUTPUT)

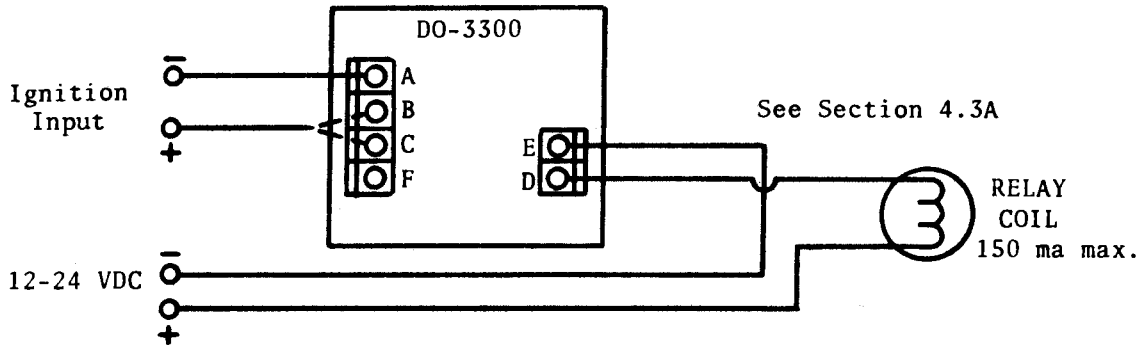

AC OR DC CONTROL SYSTEM (LATCHING OUTPUT)

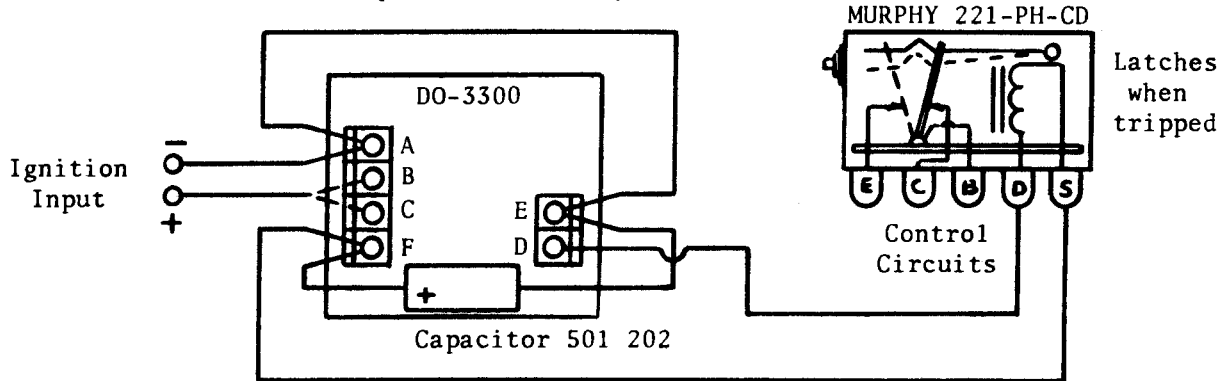

PNEUMATIC CONTROL SYSTEM

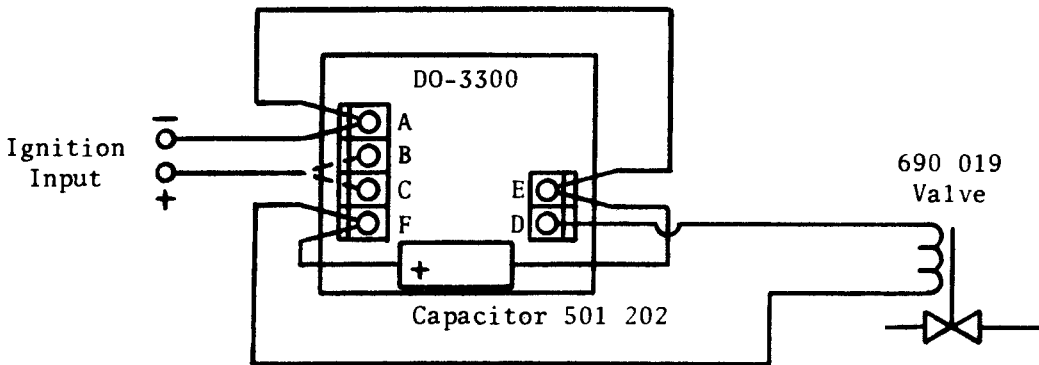

WIRING DIAGRAMS- DO-3300A

NEGATIVE GROUND IGNITION - DIRECT SHUTDOWN, NO ANNUNCIATION

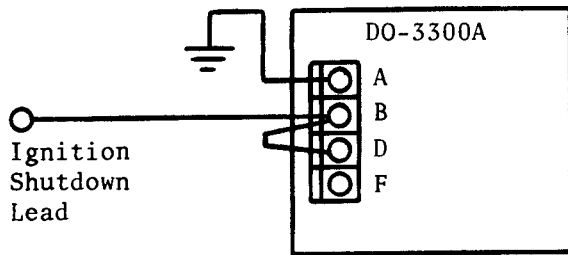

NEGATIVE GROUND IGNITION - MURPHY TATTLETALE

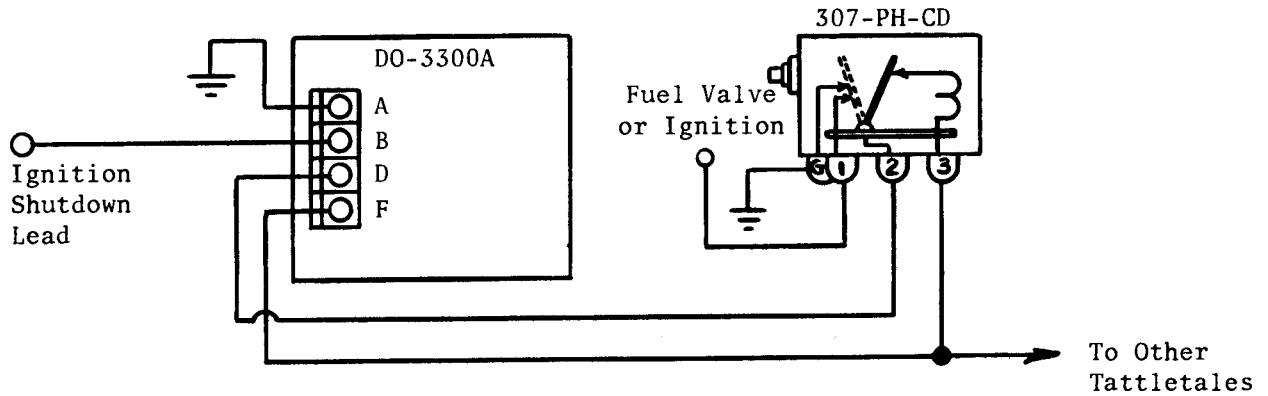

NEGATIVE GROUND IGNITION - ALTRONIC ANNUNCIATOR

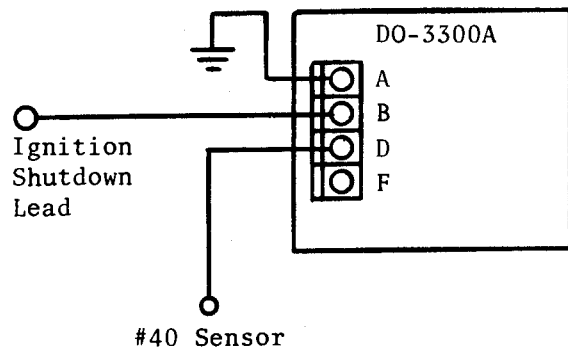

NOTE: DO-3300A is connected as a normally open sensor on a normally closed annunciator system.

WIRING DIAGRAMS - DO-3300A

POSITIVE GROUND IGNITION - DIRECT SHUTDOWN, NO ANNUNCIATION

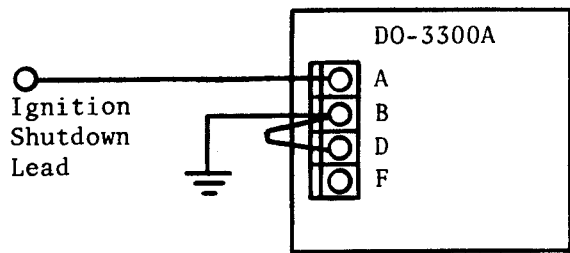

POSITIVE GROUND IGNITION - MURPHY TATTLETALE

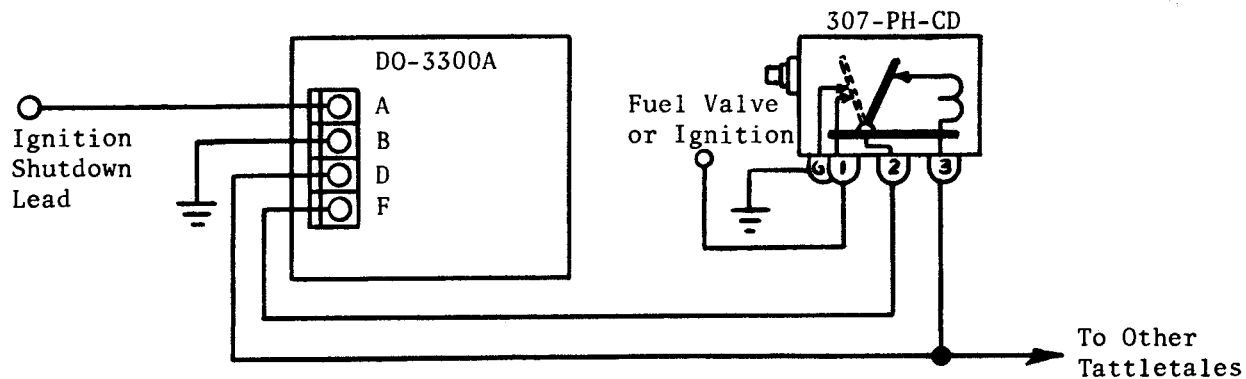

PNEUMATIC CONTROL SYSTEM

