

# Installation & Operating Manual

PMM - Power Management Module

Form PMM IOM 12-20

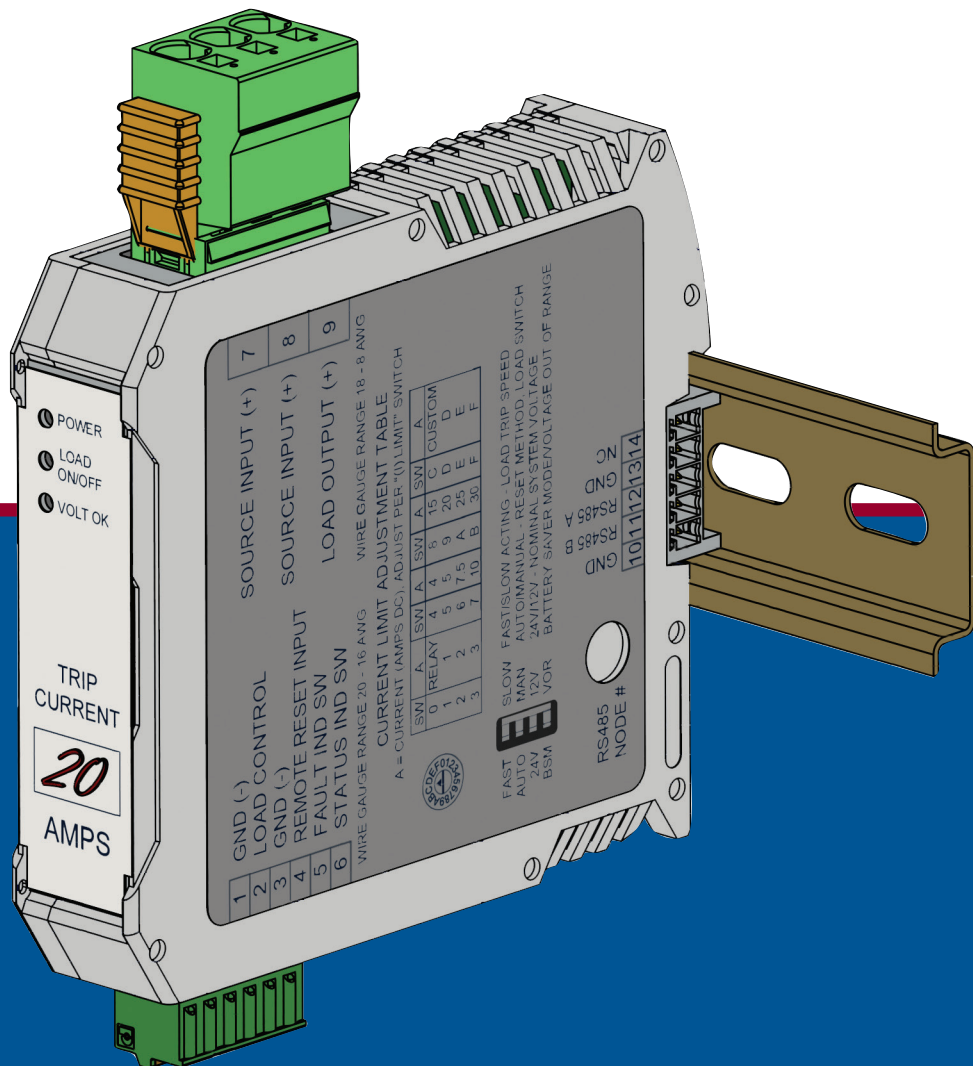

## 1.0 POWER MANAGEMENT MODULE DESCRIPTION

- 1.1 The Power Management Module (PMM) is a smart load protection device used to protect an electrical circuit from damage caused by an overload condition or short circuit. Its basic function is to detect a fault condition and interrupt current flow. Unlike a fuse, which is a one-time device, the PMM can be reset (either manually, automatically or remotely) to resume normal operation. The PMM uses a solid-state high-side switch that is protected in case of extreme overload, output shorts to ground, and thermal conditions. It is also protected from reverse connection currents. A single PMM can be configured to trip at several breaker currents from 1 to 30 amps. The PMM also can be configured for “fast” or “slow-acting” trip response times.
- 1.2 The PMM can also be used as a solid-state relay (SSR). The PMM contains a solid-state high-side power switch that can be controlled by grounding or un-grounding a load control signal input, or by Modbus. The high-side switch can switch currents up to 30 amps at voltages between 10 and 32 volts DC. Unlike a mechanical relay, the PMM has no moving parts to wear out and is not required to be hermetically sealed to be used in Div. 2 locations. When used as an SSR it can be configured to trip with no delay time or as a time delay relay. The PMM is limited to SPST switching.
- 1.3 The PMM can act as a battery saver. A battery saver is used to prevent the discharge of cranking batteries by automatically disconnecting the load at a preconfigured value. The PMM contains circuitry that measures the source input voltage to the module. Load disconnect can occur upon recognition of a low voltage condition caused by the loss of charging current either from an alternator or a line powered charger. When it senses the loss of the charging current it will disconnect the load preventing further battery drain. The PMM can be configured for an immediate notification of the loss of charging current with or without a time delay for load disconnect. The user can be notified either by a remote output switch or Modbus communication. The PMM can be configured to auto-reclose when the voltage returns to an acceptable value or manual reclose through a manual or remote reset. This will allow for servicing of the condition without the load being immediately disconnected. The PMM can also be configured to react to under-voltage and or over-voltage conditions as well.
- 1.4 The PMM is full featured as a Power Management Module. It contains diagnostic LED's, remote indication output switches, local and remote test and reset functions, as well as Modbus RTU serial communications for supervisory computer monitoring and control.
- 1.5 The PMM is housed in a space saving 3.9" (99mm) x 4.5" (114.5mm) x 0.89" (22.5mm) rugged ABS housing. It quickly and reliably mounts on a common 35 mm DIN rail. It uses a DIN rail BUS connector for its communication connection. Pluggable Phoenix Contact-type connectors with push-in spring-cage connectors are used for connections. The Power/load connector can accept wire gauge sizes from 18 to 8 AWG. It has a latching lock feature to prevent accidental disconnects.
- 1.6 The PMM is designed for nominal 12 volt or 24 volt powered systems. The power requirement is 10 to 32Vdc, load current 30 amps max, operating current is 30 milliamps max, and in Battery Saver Mode, 10 milliamps max.
- 1.7 For proper operation, these instructions must be adhered to strictly.

**WARNING: DEVIATION FROM THESE INSTRUCTIONS MAY LEAD TO IMPROPER ENGINE OPERATION WHICH COULD CAUSE PERSONAL INJURY TO OPERATORS OR OTHER NEARBY PERSONNEL.**

**CAUTION: THE PMM POWER MANAGEMENT MODULE IS CERTIFIED FOR USE IN CLASS I, GROUPS C & D, DIVISION 2 HAZARDOUS LOCATIONS WHEN INSTALLED IN ACCORDANCE WITH THESE INSTRUCTIONS.**

**THE SOURCE, LOAD, AND CONTROL LEADS OF THIS MODULE OPERATE AT A LOW VOLTAGE AND POWER LEVEL AND MUST NOT CONTACT ANY EXTERNAL VOLTAGE SOURCE. DAMAGE TO THE SYSTEM WILL RESULT FROM CONNECTION BETWEEN THE INPUT SENSOR LEADS AND THE IGNITION SYSTEM OR ANY AC OR DC POWER SOURCE ABOVE 36 VDC**

**WARNING: THE POWER MANAGEMENT MODULE MUST BE CONFIGURED PRIOR TO USE.**



**CERTIFIED CLASS I,  
DIVISION 2  
GROUPS C AND D**

## 2.0 MOUNTING

### 2.1 POWER MANAGEMENT MODULE (PMM) (See Figure 1)

Mount the PMM inside a control panel or to a suitable flat surface in a control box. An integrated DIN-rail-mounting-clip on the bottom of the module is used to mount the unit on a standard 35mm DIN rail. When mounting the module, strive to mount the larger connector (Source In and Load Out) up. This will allow for the best heat dissipation out of the Module without traveling through it.

When mounting the Module to the DIN rail, angle the top of the unit away from the rail; slide the fixed hook onto the rail, rock the module onto the rail until it snaps into place.

To remove, insert a small flat blade screwdriver into the rectangular cutout in the metal latch. Pull the latch away from the rail and rock the module out of the rail.

- 2.2 When using the Modbus serial communications feature of the PMM a 5 position bus connector is required; Altronic P/N 604425. The bus connector is positioned in the DIN rail. The Module is mounted on the rail by rocking it in the usual way, but over the bus connector. The bus connector will make the RS485 connections inside the module. The bus connector is connected to either other PMM Modules or to a connector; Altronic P/N 604427. The communication method allows for individual PMM Modules to be removed without disrupting the communications connection chain.

## 3.0 WIRING (SEE WIRING DIAGRAMS)

### 3.1 GENERAL

Take care not to damage the insulation and take precautions against damage from vibration, abrasion or liquids in conduits. Never run sensor, low voltage power, communications, or output switch wires in the same conduit as the ignition wiring or other high energy wiring such as AC line power, etc. Keep wires at least **12 inches** away from all high voltage wiring.

Keep secondary wires to spark plugs and other high voltage wiring at least **12 inches (305mm)** away from vibration sensors and their wiring.

### 3.2 CONNECTORS

The connectors on the PMM are Phoenix type spring-cage pluggable connectors. The 3-position source input / load output connector can handle currents up to 41 amps continuous and accept wire gauge sizes from 18 to 8 AWG. It has a tool less click-and-lock retention system to assure its connectivity. Slide the orange tabs in and pull on the connector for removal. Use the appropriate wire gauge for the selected current range. A chart is provided for proper wire gauge selection.

The 6-position ground and auxiliary connector can accept wire gauge sizes from 20 to 16 AWG.

The 5-position integrated bus connector is used for the RS485 communications.

### 3.3 SOURCE/LOAD AND GROUND WIRING

The source input / load output connector can handle currents up to 41 amps continuous. It accepts wire gauge sizes from 18 to 8AWG. Use the appropriate wire gauge for the selected current range. **A chart is provided for proper wire gauge selection.** There are two terminals for the source wiring and one for the load. This allows for the source wires to be conveniently connected to other PMM's by using the second input terminal. Connect the source input wire to the **Source Input (+)**. Connect the **Load Output (+)** wire to the load. Connect the minus terminal **GND (-)** to panel ground, which must be the same as the source ground. Operating voltage range is **10 to 32Vdc**, Load current is 30 amps max. Operating current is **30 milliamps max.** Power is typically from a DC battery or a DC power supply. Nominal voltage is either 12 Vdc or 24 Vdc. If the PMM is powered from a DC power supply it must be rated as Class 2.

**WARNING: THIS MODULE IS OPEN-TYPE EQUIPMENT THAT MUST BE USED WITHIN A SUITABLE ENCLOSURE.**

**NOTE: ALTRONIC HIGHLY RECOMMENDS THE USE OF RESISTOR SPARK PLUGS AND/OR SPARK PLUG LEADS WITH ALL DIGITAL INSTRUMENTATION AS A MEANS OF REDUCING THE IMPACT OF RFI (RADIO FREQUENCY INTERFERENCE) ON OPERATION.**

**Important: For proper operation the GND (-) terminal (located on the control terminal block) must be connected to the supply minus.**

**DO NOT CONNECT THE MINUS TERMINAL DIRECTLY TO AN IGNITION SYSTEM COMMON COIL GROUND ON THE ENGINE.**

### 3.4 REMOTE CONTROL AND OUTPUT INDICATION WIRING

The PMM has several I/O connections. The REMOTE LOAD CONTROL, REMOTE RESET INPUT, FAULT INDICATION OUTPUT SWITCH, and STATUS INDICATION SWITCH. Use nominal 16 to 20 AWG wire for these remote I/O connections. When leaving the panel these wires should be run in rigid conduit or Sealtite/Liquidtite to protect the wires from breakage.

### 3.5 RS485 SERIAL COMMUNICATIONS WIRING

The PMM can communicate serial Modbus data to the panel controller via the integrated terminal bus connector, Altronic P/N 604425. The bus connector is snapped into the DIN rail and the PMM is rocked into place over the DIN rail connector. Additional PMM Modules are connected in the same manor, slid next to each other establishing RS485 connectivity. Plugging and unplugging of individual PMM modules is possible without breaking the RS485 signal. A pluggable connector, Altronic P/N 604427 is used to make the connection from the end bus connector to the controller. Pin 1 is shield (ground), pin 2 is RS485 (B), and pin 3 is RS485 (A).

### 3.6 HAZARDOUS AREA OPERATION

The PMM is **CSA certified** for **Class I, Division 2, Groups C & D** areas as a component only and is required to be installed in a suitable enclosure where the suitability of the combination is subject to the local inspection authority having jurisdiction. The power connections to the PMM must be in accordance with the **National Electrical Code** and in Canada, the **Canadian Electrical Code**. In addition, the following requirements must be met:

1. **Run the wires leaving the panel in a separate conduit from all other wiring and keep them separate throughout the installation.**
2. **Power, input, and output wiring must have a grade of insulation capable of withstanding an AC voltage of 500 volts RMS.**
3. **In general, run wires in separate conduits and junction boxes from high voltage wires such as ignition, fuel valve, and other high voltage wiring.**

**WARNING EXPLOSION HAZARD:  
DO NOT DISCONNECT EQUIPMENT IN  
DIV. 2 ENVIRONMENT UNLESS POWER  
IS SWITCHED OFF OR THE AREA IS  
KNOWN TO BE NON-HAZARDOUS.**

## 4.0 OVERVIEW

4.1 The Power Management Module (PMM) functions as a “smart” power switch/circuit protector used to protect wiring and electrical equipment from over-current conditions. The PMM contains a high power controllable high-side power switch with programmable current limit. It can monitor and drive various loads detecting over current, under voltage, and over voltage conditions. The PMM combines the functions of a Solid State Circuit Protector, a solid state relay and a low voltage detector/battery saver in a single package. The PMM is designed to replace traditional fuses/circuit breakers, Div 2 rated hermetically sealed relays, Class 1 Div 2 rated power switches, and low voltage detection systems.

4.2 When used as a solid state over-current circuit protector a single PMM can be set for current ranges from 1 to 30 amps, fast or slow acting using mechanical configuration switches. The PMM has local and remote “Trip” and “Reset” switches. It also has local and remote fault and status indicators. The load switch can be set for latch (requiring a manual reset) or auto retry (the load switch will automatically reclose in the absence of the over-current condition).

The PMM contains a time-current curve similar to US automotive fuses. Per the US standard for fuses, the PMM will carry the selected current value without tripping. Once the load current exceeds the configured current, the time it takes to trip will be determined by how much it exceeds it. It will follow a time-current curve to determine trip time. In general, trip time will be instantaneous at high levels of overloads and be delayed for low to medium current levels above the trip point. The PMM’s time-current curve can be found in the drawings section of the manual.

- 4.3 When used as a solid state relay the PMM can control loads up to 30 amps. The voltage range is 10 to 32 volts dc. The relay can be configured to trip immediately or as a time delay relay. The remote on/off control input is a low voltage, low current input and is configurable to activate the relay by either grounding or releasing (opening) the input. There are both local (LED) and remote (indicator switch) load on/off status indicators.
- 4.4 The PMM can be used as a “battery saver” to disconnect the load from the battery to prevent damage to the battery and wasted time waiting to recharge a dead battery. The PMM will monitor the battery voltage to detect for a loss of charging current from either an Alternator or a line powered charger. When it senses the loss of the charging current it will disconnect the load preventing further battery drain. The PMM can be configured for an immediate notification of the loss of charging current with or without a time delay for load disconnect. The PMM will either auto-reclose or can be reclosed remotely or manually upon the return to an acceptable voltage level condition. This will allow for servicing of the condition without the load being immediately disconnected. The system can be configured for either 12 or 24 volt nominal voltage systems. The PMM can also be configured to react to under-voltage and or over-voltage conditions as well.
- 4.5 The PMM can be configured, controlled, and monitored via the onboard RS485 Modbus communications. See the Modbus register list at the back of the manual.
- 4.6 The PMM is rated for Class I, Div 2, hazardous areas.
- 4.7 The PMM is designed to work with 12 or 24 volt nominal systems.

## 5.0 TOP PANEL INDICATORS, CONFIGURATION AND CONTROL SWITCHES

### 5.1 TOP PANEL LED'S

The PMM contains three LED indicators, Power, Load On/Off, Voltage OK. The LED's are bicolored red and green, with green being the normal condition and red being an out-of-range condition.

- **POWER** – When the unit is powered the “POWER” LED will illuminate green.
- **LOAD ON/OFF** – The load LED will illuminate:
  - Green** – when the load switch is on or closed, connected through from source to load; normal operation below selected trip current
  - Alternate Green/Red** – when the load current is above the selected current limitation trip point but below the open or switched off point
  - Red** – when the load switch is off and no current is passing from source to load; an overcurrent trip point has been reached
- **VOLT OK** – The voltage OK LED will illuminate green when the source voltage is within the normal range. It will turn red when the voltage is outside the configured and selected acceptable voltage range. The selected range is set by the 12/24 volt toggle switch. The type of monitoring is set by the Battery Saver Mode (BSM) / Voltage Out of Range (VOR) switch. The Battery Saver Thresholds and the acceptable voltage ranges are configured via Modbus.

**BSM** – When set to Battery Saver Mode, the VOLT OK LED is green when the source battery is being charged, but turns red if charging current is lost. The default for a 12 volt system is 12.5 volts, for a 24 volt nominal system the default is 25 volts.

**VOR** - When set to Voltage Out of Range mode the VOLT OK LED will be green when the nominal voltage is between the selected range. If the voltage drops to either below the low voltage or above the high voltage acceptable range the LED will turn red. The defaults are 10 and 14 volts for the 12 volt nominal voltage switch setting, and 18 and 36 volts for 24 volt nominal voltage switch setting.

## 5.2 CURRENT LIMIT AND CONFIGURATION SWITCHES

The PMM contains two separate sets of configuration switches. The current (I) Limit switch and the function configuration switch.

### ■ CURRENT LIMIT SWITCH:

The current limit switch is used to set the trip current. The current limit switch is a 16 position hexadecimal rotary switch accessible from the top panel. The trip current can be set from 1 to 30 amps. Use switch position “0” when the PMM is used as a SSR (Solid State Relay). Use switch position “C”, “D”, “E”, or “F” when a custom trip table is required. Simply use a small blade screwdriver to rotate the switch to the desired setting. See table below for trip current setting:

**Current Limit Adjustment Table**

sw pos	Trip current (amps)
0	SS relay
1	1
2	2
3	3
4	4
5	5
6	7.5
7	10
8	15
9	20
A	25
B	30
C	custom
D	custom
E	custom
F	custom

### ■ FUNCTION CONFIGURATION SWITCH:

The function configuration switch is a 4-position DIP switch accessible from the top panel. The 4-position DIP switch performs the following configurations:

**SW 1** – Use switch position 1 to select between **Fast or Slow acting** load trip speeds. The PMM emulates a fast-acting or a slow-acting fuse type. See the time-current curves in the back of the manual to determine which would work best for the application.

**SW 2** – Use switch position 2 to select between **auto reset or manual reset** (latch) for the load switch.

When set to the “Auto Reset” position and the load switch trips (opens) on an overload condition and when the overload condition is removed the load switch will reclose automatically. The retrigger delay and number of retries can be customized via Modbus. The default settings are 10 seconds between retries for 5 retries.

When the switch is set to the “Latch” position and the load switch trips (opens) on an overload condition, it will stay tripped until reset manually. The load switch can be reset manually by several methods; pressing the **manual Reset** button on the top panel, using the **remote reset** on the control terminal block, and by sending the reset **Modbus command** via serial communications.

**SW 3** – Switch position 3 is used to select the **nominal system voltage** for the voltage detect. Set it to 12V for 12 volt nominal systems or to

**NOTE: DO NOT SET THE CURRENT LIMIT SWITCH TO ONE OF THE CUSTOM SWITCH SETTINGS UNLESS A CUSTOM PROFILE WAS CREATED.**

24V for 24 volt nominal systems. This switch works in conjunction with the Battery Saver Mode/Voltage-Out-of-Range detect system in the PMM. When the source voltage is within the configured operating voltage range the panel LED will be green and the status switch will be off.

**SW 4** – Switch position 4 is used to turn the **Battery Saver Mode (BSM) ON** or the **Voltage Out of Range mode (VOR) ON**. See section **9.0 BATTERY SAVER MODE OPERATION** for a description of the BSM operation. See section **9.1 VOLTAGE OUT OF RANGE MODE OPERATION** for a description of the VOR operation.

**Function Configuration Table**

SW	Function	Description	Switch Position	
			Left	Right
1	Fast/Slow Acting	Load Trip Time	Fast	Slow
2	Auto/Manual Reset	Load Switch Reset Type	Auto	Manual
3	24/12 volt	System Voltage (nominal)	24V	12V
4	BSM/VOR	Battery Saver Mode or Voltage Out of Range	BSM	VOR

### 5.3 TRIP AND RESET SWITCHES:

**TRIP** – The PMM can be tested by pressing the trip switch on the top of the module. When the trip switch is pressed the load switch opens and the load is disconnected from the source.

**RESET** – Pressing the reset switch on the top of the module resets the load switch and the load is reconnected to the source.

### 6.0 SOURCE/LOAD TERMINAL BLOCK

The source/load terminal block serves as the source and load connections for the PMM. The source input/load output connector can handle currents up to 41 amps continuous. It accepts wire gauge sizes from 18 to 8AWG.

- **SOURCE INPUT (+), Terminals 7 and 8** – There are two terminals (7 and 8) for the source wiring. This allows for the source wires to conveniently be connected to other PMM's by using the second input terminal. Connect the source input wire from the battery/power supply (+) to the **SOURCE INPUT (+), Terminal 7**. Use the second **SOURCE INPUT (+), Terminal 8** to source other Power Management Modules. Note: Terminals 7 and 8 are connected internally.
- **LOAD OUTPUT (+), Terminal 9** – Terminal 9 is for the load wiring. Connect the **LOAD OUTPUT (+)** wire to the load.

### 6.1 CONTROL TERMINAL BLOCK

The control terminal block serves as:

1. The supply minus or ground connection point for the PMM.
 

Note: The PMM must be connected to power supply minus on the GND (-) terminal of the connector to operate correctly.
2. The connection point for various remote control and diagnostic functions.
  - **GND (-), Terminal 1** – Terminal 1 is the **preferred ground connection** for the PMM. Terminal 1 or 3 must be grounded for proper operation. Terminal 1 is the ground connection for the load control function. Terminals 1 and 3 are connected internally.
  - **LOAD CONTROL, Terminal 2** – Terminal 2 is the **Load Control** terminal. The remote on/off **LOAD CONTROL** input is a low voltage, low current sinking input. It is internally sourced and requires only the grounding of this terminal for activation. The load control function is configurable to activate

the **LOAD OUTPUT** by either grounding or releasing (opening) the input. When the Load Control terminal is released, (ungrounded) the load will be connected to the source. When the **LOAD CONTROL** terminal is grounded the load will be disconnected from the source. Configure the remote on/off **LOAD CONTROL** input to activate the relay by either grounding or releasing (opening) the input to close the switch (modbus register 00001).

**1 = ground** the load control input **to close the load switch**

**0 = release** the load control input **to close the load switch**

Note: The default is - ground terminal 2 to open the load.

- **GND (-), Terminal 3** – Terminal 3 is the **ground connection** for the remote reset function. Terminals 1 and 3 are connected internally.
- **REMOTE RESET, Terminal 4** – Terminal 4 is the **Remote Reset Input** terminal. Momentarily grounding terminal 4 will reset the PMM. It is internally sourced and requires only a momentary grounding of this terminal for activation. Note: For proper operation of the remote reset a momentary push button type switch must be used. A transition from low to high must be seen. This terminal functions the same as pressing the reset button on the top of the module.
- **FAULT IND SW, Terminal 5** – Terminal 5 is the **Fault Indication** remote switch. The fault switch will turn on to ground to indicate a fault condition (when the “breaker” or SSR opens). The switch can be wired to, telematics systems, engine management systems or to an Altronic annunciator system. The fault switch is rated at 32Vdc, 200mA
- **STATUS IND SW, Terminal 6** – Terminal 6 is the **Status Indication** remote switch. When set to **BSM** mode the status switch will turn on to ground to indicate when the PMM enters **BSM**, battery saver mode. When set to **VOR** mode the status switch will turn on to ground when the voltage is either below the low setpoint or above the high setpoint. The switch can be wired to, telematics systems, engine management systems or to an Altronic annunciator system. The fault switch is rated at 32Vdc, 200mA.

## 7.0 OVER-CURRENT CIRCUIT PROTECTION

To use the PMM as a solid state over-current circuit protector, use the mechanical configuration switches and set the trip current, the trip time (fast or slow acting), the load switch to latch or auto reset, and the nominal system voltage 12 or 24 volt. Upon completion of the desired configuration, press the Reset switch to reset and close the circuit protector. The load switch LED will go from red to green indicating the load switch is closed and current is travelling from the source to the load. The “circuit protection” function can be tested at any time by pressing the Trip switch.

### Steps to configure the PMM for over-current circuit protection:

- Set the **(I) Limit** (Current Limit) rotary configuration switch on the top of the module to the desired trip current value. (see Current Limit Adjustment Table printed on the Module and in this manual)
- Set the **Fast/Slow** configuration switch on the top of the module for the desired trip speed, fast or slow acting.
- Set the **Manual/Auto Retry** configuration switch on the top of the module to latch **Manual** (requiring a manual reset) or **Auto Retry** (the load switch will try to automatically reclose in the absence of the over-current condition). Note: Refer to Modbus registers 40145 and 40146 to customize the retry delay and the number of retries.
- Set the **12/24 volt** configuration switch on the top of the module for the nominal system source voltage.
- If Modbus is being used, set the **node number** using the RS485 Node number rotary switch on the side of the Module. Note – Switch pos 1 is node #1, switch pos 2 is node #2, etc. Switch position 0 is node #10.
- Press the **RESET** button on the top of the module.



## 7.1 INFLUENCE OF WIRE GAUGE/LENGTHS AND UNDER SIZED POWER SUPPLIES WITH THE PMM

Long wire lengths and under sized wires to the source input of the PMM can influence the current that the PMM sees. This could prevent the proper protection of the circuit by delaying the safety trip or possibly not tripping at all.

Please observe the following guidelines:

- Use proper sized wire for the trip current selected. A current/wire gauge table can be found at the end of the manual, refer to Figure 4.
- Use a proper sized power source for the trip current selected; at least 5x over the trip current selected.

## 7.2 BREAKER CHARACTERISTICS

The PMM contains a time-current curve similar to US automotive fuses. Per the US standard for fuses, the PMM will not trip until the load current is approximately 1.4 times above the selected trip current value. How rapidly the PMM trips depends on two factors; 1 – the selection of either fast or slow acting, and 2 – how far over the load current exceeds the configured current. It will follow the selected time-current curve to determine trip time. In general, trip time will be instantaneous at high levels of overloads and be delayed for low to medium current levels slightly above the trip point. The PMM’s time-current curve can be found in the drawings section of the manual, refer to Figures 2 and 3. A custom time/current table can be entered using Modbus. Set the trip current selection switch to position “C”. Consult the factory if a custom time/current table is required.

The PMM contains temperature compensation to keep the current trip accuracy over the operating range of -40°C to 85°C.

## 8.0 SOLID-STATE RELAY

When used as a solid state relay the PMM can control loads up to 30 amps. The voltage range is 10 to 32 volts dc. The relay can be configured to trip immediately or in a configurable time delay. The remote on/off **LOAD CONTROL** input is a low voltage, low current input and is configurable to activate the relay by either grounding or releasing (opening) the input. There are both local (LED) and remote (indicator switch) load on/off status indicators. New firmware for 2020 adds Modbus register 40002, which maps to bit 00017 as a means of having a Modbus command which performs the equivalent to grounding Terminal 2.

To use the PMM as a solid state relay set the current limit switch to “0” (ss relay setting), the configurable time delay (via Modbus Register 40149), and the nominal system voltage **12** or **24 volt** (top panel configuration switch). The load switch LED will indicate locally when the relay is open (red) or closed (green). Use the **LOAD CONTROL** terminal on the module to control the relay. The relay function can be tested at any time by pressing the **TRIP** switch to open the load and the **RESET** switch to close the load. The remote Status and Fault indicator switches can be used for remote status feedback of the “relay” state.

Be aware that it is possible to combine the overcurrent protection along with the ss relay function. When the current limit switch is set to position “0” (the ss relay setting) the load switch will not trip on overcurrent unless a short is detected. If it is desired to use the PMM as both a solid state relay and circuit protector, set the current limit switch to the desired overcurrent value. The load will be controlled by the Load Control input, same as with the current limit switch set to “0”, but the load switch will open independent of the load control input if the load exceeds the set value.

### Steps to configure the PMM for solid-state relay operation

- Set the **(I) Limit** (Current Limit) rotary configuration switch on the top of the module to position “0”, the ss relay setting. Note that the module will carry up to 30 amps of continuous current. If it is desired to use the PMM as a “circuit breaker” as well as an “ss relay” the current limit

**FOR UNITS WITH FIRMWARE DATED 12/20 AND AFTER**

*Set modbus register 00003 to a '1' for applications when the PMM is used as a solid state relay. This eliminates toggling of the output switch on power-up when configured for a normally open output.*

**NOTE – THE DEFAULT VALUE FOR THE CONFIGURABLE TIME DELAY IS ZERO.**

switch can be set to the desired trip current, however it will follow the time/current curve if the current is above the set limit. (see Current Limit Adjustment Table printed on the Module and in this manual)

- Set the trip delay time using Modbus register number 40149.
- Configure the remote on/off **LOAD CONTROL** input to activate the relay by either grounding or releasing (opening) the load control input (modbus register 00001, **1 = ground** the load control input **to close the load switch**, **0 = release** the load control input **to close the load switch**. Note: the default is ground to open.
- Set the Modbus register 00003 to a 1. Starting with firmware dated 12/20, setting this bit to a 1 eliminates a momentary toggle of the output switch on power-up when the output is configured for normally open SSR.
- Set the **12/24 volt** configuration switch on the top of the module for the nominal system source voltage.
- If Modbus is being used, set the node number using the RS485 Node# rotary switch on the side of the Module. To control the load switch via Modbus control, set bit 00017 to a '1', which will (typically) open the output switch. This bit is also mapped as '1' for Modbus register 40002. Writing a '0' to register 00017 will (typically) close the output switch. This Modbus register is a RAM function only and will not be retained during a power-down if set to a '1'. On power-up, register 00017 will always come up as a '0'. Note that this write does not need the 40200 register write protection to use this feature. Note that this function follows register 00001 which configures register 00017 to activate the relay by either writing a "0" or a "1".

## 9.0 VOLTAGE DETECTION

The PMM monitors, and can act upon, the voltage seen at its Source Input terminals. Voltage detection in the PMM is grouped into either 12 or 24 volt nominal systems and either a battery protection system (BSM) or a power supply out of range (VOR) system. The 24/12V mechanical configuration switch is used to select the nominal system voltage and the BSM/VOR mechanical configuration switch is used to select either Battery Saver Mode (BSM) or Voltage Out of Range (VOR) mode. There are two adjustable voltage level setpoints for each mode, undervoltage and overvoltage detection.

### 9.1 BATTERY SAVER MODE OPERATION

The PMM can be used as a battery saver to prevent the discharge and possible damage of cranking batteries. To use the BSM mode set the BSM/VOR switch to BSM. There are two setpoints, a low and a high setpoint. The low setpoint can be used to monitor the battery charging circuit for a malfunction of the charging circuit. Should this occur the PMM will automatically disconnect the load at a configured low voltage level and time to prevent further discharge of the battery. An example would be if the battery charging circuit fails due to an alternator/regulator failure. The high setpoint can be used as an overcharge detector. Should the voltage level exceed the high setpoint in the PMM it will send out a warning signal (via the Status Indicator switch) that the charge level has reached a point of possible battery damage by overcharge current. This allows the user to take appropriate action to prevent battery failure.

A low voltage condition on a nominal 24 volt system operates as follows:

For a 24 volt nominal battery system with charger, the charge voltage is typically between the range of 25.0 to 31.0 volts. Should the supply voltage reach the low voltage setting of below 25.0 volts the hold-off-delay timer will commence. This time is short, typically 10 seconds, used for starter motor engagement or other large switched-in loads that cause a voltage dip of the source voltage. Upon time-out of the 'hold-off-delay timer', the 'BSM trip delay timer' commences; typically set to 30 minutes. The front panel "Volt OK" LED will blink red/green and the 'status output switch' will close; terminal 6 on PMM. This timer will allow the panel to run for some time to allow the possibility of the charge voltage to return and to allow the operator to fix the problem without a disconnect. When the 'BSM trip delay timer' times out the "Volt OK" front panel LED will turn red and the load will be disconnected from the

source by the PMM to protect the battery from being discharged to a level that will disallow a restart of the engine. The front panel LED's will cycle on/off in sequence indicating that the PMM is in low power mode. A reset is required to reconnect the load.

A low voltage BSM condition can be reset by the following methods:

- A manual reset will occur by pressing the reset switch on the top of the Module.
- A remote reset will occur by momentarily connecting the **REMOTE RESET INPUT**(Terminal 4) to ground **GND** (Terminals 3 or 1) refer to **Figure 7**.
- An Auto reset will occur in BSM Mode for a low voltage condition when the voltage detected rises above the configured voltage level, 12.5V typical (for 12V systems) or 25V typical (for 24V systems) **Reg 40152** or **40153** and the BSM Recovery Delay time set in **Reg 40148** is met.

A high voltage condition on a nominal 24 volt system operates as follows:

For a 24 volt nominal battery system with charger, the charge voltage is typically between the range of 25.0 to 31.0 volts. Should the supply voltage reach the high voltage setting of above the 'BSM Hi Threshold' (31.0 volts) the "volt ok" LED will change from green to red and the status output switch will close, (terminal 6 on PMM). The user can use this as a notification that the system voltage is out of range. The source to load switch in the PMM does not disconnect the load from the source in the PMM. Once the voltage returns to 30.5 volts (there is a 5 volt hysteresis 'BSM Hi Hyst' on the high voltage setting) the "volt ok" LED will return to green and the status output switch will reopen.

Note: Voltage levels and times can be customized during commissioning of the PMM via Modbus. See the Modbus table in the back of the manual.

#### Steps to configure the PMM for Battery Saver Mode (BSM)

- Set the BSM/VOR mechanical configuration switch on the top of the module to BSM.
- Set the 24/12 volt mechanical configuration switch on the top of the module for the nominal system source voltage.
- If Modbus is being used, set the node number using the RS485 Node# rotary switch on the side of the Module.
- If desired adjust the parameters related to BSM Mode via Modbus.

#### BSM Mode

MODBUS REGISTER	DESCRIPTION	DEFAULT
40152	BSM Low Threshold 24V	25.0V
40156	BSM High Threshold 24V	31.0V
40153	BSM Low Threshold 12V	12.5V
40157	BSM High Threshold 12V	15.5V
40155	BSM Hold-off-delay (seconds)	10
40147	BSM Trip Delay (minutes)	30
40154	BSM Low Hysteresis	0.1V
40158	BSM High Hysteresis (volts)	0.5V
40148	BSM Recovery Delay (minutes)	OFF

## BSM I/O Chart

### Under Voltage Condition in BSM Mode

LED'S	WITHIN VOLTAGE RANGE	BELOW BSM SETPOINT TIMER RUNNING	BELOW BSM SETPOINT TIMER EXPIRED	VOLTAGE RECOVERY TO WITHIN RANGE BUT NOT RESET
POWER	Green	Green	Sequencing - Green	Sequencing - Green
LOAD ON/OFF	Green	Green	Sequencing - Red	Sequencing - Red
VOLT OK	Green	Blinking Red/Green	Sequencing - Red	Sequencing - Green

### OUTPUT SWITCHES

LED'S	WITHIN VOLTAGE RANGE	BELOW BSM SETPOINT TIMER RUNNING	BELOW BSM SETPOINT TIMER EXPIRED	VOLTAGE RECOVERY TO WITHIN RANGE BUT NOT RESET
FAULT IND	Open	Open	Closed	Closed
STATUS IND	Open	Closed	Closed	Open
LOAD SWITCH	Closed	Closed	Open	Open

### Over Voltage Condition in BSM Mode

LED'S	WITHIN VOLTAGE RANGE	ABOVE BSM SETPOINT	VOLTAGE RECOVERY TO WITHIN RANGE
POWER	Green	Green	Green
LOAD ON/OFF	Green	Green	Green
VOLT OK	Green	Red	Green

### OUTPUT SWITCHES

LED'S	WITHIN VOLTAGE RANGE	ABOVE BSM SETPOINT	VOLTAGE RECOVERY TO WITHIN RANGE
FAULT IND	Open	Open	Open
STATUS IND	Open	Closed	Open
LOAD SWITCH	Closed	Closed	Closed

## 9.2 VOLTAGE OUT OF RANGE OPERATION

The PMM can be used as an out-of-range voltage detector system. When set to Voltage Out of Range mode (PMM configuration switch to VOR) the VOLT OK LED will be green when the supply voltage is between the configured acceptable range. Should the supply voltage either go below the low voltage or above the high voltage settings the “volt ok” LED will change from green to red and the status output switch will close, (terminal 6 on PMM). The user can use this as a notification that the system voltage is out of range. The source to load switch in the PMM does not disconnect the load from the source in the PMM. Once the voltage returns to within the acceptable range minus the hysteresis value the “volt ok” LED will return to green and the status output switch will reopen. The default voltages can be found in the following chart.

### Steps to configure the PMM for Voltage out of Range (VOR) mode

- Set the BSM/VOR mechanical configuration switch on the top of the module to VOR.
- Set the 24/12 volt mechanical configuration switch on the top of the module for the nominal system source voltage.
- If Modbus is being used, set the node number using the RS485 Node# rotary switch on the side of the Module.
- If required adjust the parameters related to VOR Mode via Modbus.

### VOR Mode

MODBUS REGISTER	DESCRIPTION	DEFAULT
40136	24 volt VOR High Limit	36.0V
40137	24 volt VOR Low Limit	18.0V
40138	12 volt VOR High Limit	17.0V
40139	12 volt VOR Low Limit	10.0V
40140	VOR voltage hysteresis	0.5V

## 10.0 RS485 MODBUS SERIAL COMMUNICATIONS

The PMM can communicate serial Modbus data to the panel controller via the integrated terminal bus connector. The Modbus port is used to transfer data to and from a PLC, PC, or laptop computer to configure and monitor the PMM. The serial communications are compliant to the Modicon Modbus RTU standard and uses RS-485 for its hardware communication format. Maximum number of registers that can be read at one time is limited to 32. Maximum number of booleans that can be read at one time is limited to 256. The node number can be selected by the RS485 Node# switch on the side of the module. The default configuration is 38400 baud, 8 Data bits, No Parity, 1 Stop bit ( 38400 8N1 ).

Please note that when making changes to the Modbus write registers (00000 and 40000), the following sequence must be used to ensure that changes are saved to memory:

- Press the trip switch to open the load from the source.
- Write the change to the register.
- Send key command 1530 to register 40200. This will commit the change to memory.

The Modbus register list is as follows:

Location	Label	0	1	Default	Notes
Read/Write bits					
00000's	Global Functions				
00001	Load Control 0=GND to Open	Ground term 2 to Disconnect Load	Open term 2 to Disconnect Load	0	Load Control (terminal 2) 0 = Ground to disconnect load from source. Ref time delay reg 40149 on disconnect.
00002	RESERVED				
00003	SS Relay Mode	Normal	SS Relay Mode	0	FOR UNITS WITH FIRMWARE 12/20 AND AFTER SSR Mode - Set this bit to a 1 when the PMM is used as a normally open solid state relay. (the output is open on power-up)
00004	RESERVED				
00005	RESERVED				
00006	RESERVED				
00007	RESERVED				
00008	RESERVED				
00009	RESERVED				
00010	RESERVED				
00011	RESERVED				
00012	RESERVED				
00013	RESERVED				
00014	RESERVED				
00015	RESERVED				
00016	RESERVED				

Location	Label	0	1	Default	Notes
Read/Write bits					
<b>00000's</b>	<b>Global Functions</b>				
00017	Relay Control Register setting is volatile	Opens or Closes Load Switch	Opens or Closes Load Switch	0	Relay Control register follows the control of register 00001. See section 8.0 for more information.

Location	Label	0	1	Notes
Read only bits				
<b>10000's</b>	<b>Global Functions</b>			
10001	RESERVED			
10002	RESERVED			
10003	Load Switch Closed	Open	Closed	Load Output Switch Open or Closed to Source Input
10004	RESERVED			
10005	RESERVED			
10006	RESERVED			
10007	RESERVED			
10008	(VOR/BSM) Voltage OOR (Low)	in range	out of range	Voltage Out Of Range (Low) for both VOR and BSM
10009	(VOR/BSM) Voltage OOR (High)	in range	out of range	Voltage Out Of Range (High) for both VOR and BSM
10010	Current Exceeds Rated Value	in range	out of range	Current Exceeds Set Value
10011	(BSM) Battery Saver Active	No	Yes	Enters Battery Saver Mode
10012	RESERVED			
10013	RESERVED			
10014	RESERVED			
10015	RESERVED			
10016	RESERVED			
10017	Trip due to Over Current	No	Yes	Trip due to Over Current
10018	Trip due to Protection Mode	No	Yes	Trip due to Protection Mode
10019	Trip due to Not Enabled	No	Yes	Trip due to Not Enabled
10020	Trip due to Manual Trip	No	Yes	Trip due to Manual Trip
10021	Trip due to Invalid Profile	No	Yes	Trip due to Invalid Profile
10022	Trip due to Profile Changed	No	Yes	Trip due to Profile Changed
10023	Trip due to Retrigger Retries	No	Yes	Trip due to Retrigger Retries
10024	Trip due to Battery Saver (BSM)	No	Yes	Trip due to Battery Saver

Location	Label	0	1	Notes
Read only bits				
<b>10000's</b>	<b>Global Functions</b>			
10025	RESERVED			
10026	RESERVED			
10027	Trip due to Modbus Write	No	Yes	Trip due to Modbus Write
10028	RESERVED			
10029	RESERVED			
10030	RESERVED			
10031	RESERVED			
10032	RESERVED			

Location	Label	Notes
Read only bytes		
<b>30000's</b>	<b>Global Functions</b>	
30001	Inputs 1-16	Load Switch Status
30002	Inputs 17-32	Trip Reasons
30003	RESERVED	
30004	RESERVED	
30005	Load Current (Filtered*10)	Load Current *10 (Filtered)
30006	Load Current @Last Trip	Load Current *10 @Last Trip
30007	Source Voltage (V*10)	Source Voltage (V*10)
30008	Switch Temperature (K*10)	Switch Temperature (K*10)
30009	Profile In Use (1-32)	Profile In Use (1-32) see table below
30010	Current Rating (A*10)	Current Rating (Amps*10); (I) Limit switch setting
30011	Table Fast/Slow/Cstm/ None	0=Fast, 1=Slow, 2=Custom, 3=None
30012	RESERVED	
30013	RESERVED	
30014	RESERVED	
30015	RESERVED	
30016	RESERVED	

**Trip Current Profile Table (reference register 30009)**

Profile Number	Rating (Amps)	Speed	Profile Number	Rating (Amps)	Speed
1	SS Relay	DNA	17	SS Relay	DNA
2	1	Slow	18	1	Fast
3	2	Slow	19	2	Fast
4	3	Slow	20	3	Fast
5	4	Slow	21	4	Fast
6	5	Slow	22	5	Fast

**Trip Current Profile Table (reference register 30009)**

Profile Number	Rating (Amps)	Speed	Profile Number	Rating (Amps)	Speed
7	7.5	Slow	23	7.5	Fast
8	10	Slow	24	10	Fast
9	15	Slow	25	15	Fast
10	20	Slow	26	20	Fast
11	25	Slow	27	25	Fast
12	30	Slow	28	30	Fast
13	Cstm	Cstm	29	Cstm	Cstm
14	Cstm	Cstm	30	Cstm	Cstm
15	Cstm	Cstm	31	Cstm	Cstm
16	Cstm	Cstm	32	Cstm	Cstm

Location	Label	Min	Max	Default	Notes
Read/Write bytes					
<b>40000's</b>	<b>Global Functions</b>				
40001	COILS 1-16	00000	65535	0	Load Control bit
40002	Opens or Closes Load Switch	00000	00001	0	Relay Control register follows the control of register 00001. See section 8.0 for more information.
40003 through 40135	RESERVED				
40136	24Volt VOR High Limit (*10)	10	400	360	24Volt System High Limit (*10) [VOR]
40137	24Volt VOR Low Limit (*10)	10	400	180	24Volt System Low Limit (*10) [VOR]
40138	12Volt VOR High Limit (*10)	10	400	170	12Volt System High Limit (*10) [VOR]
40139	12Volt VOR Low Limit (*10)	10	400	100	12Volt System Low Limit (*10) [VOR]
40140	VOR Voltage Hysteresis (*10)	0	10	5	Voltage Hysteresis (*10) [VOR]
40141	Load Current Filter	0	255	240	Filter value for Measured Current
40142	Temperature Filter	0	255	100	Filter value for Measured Temperature
40143	Supply Filter	0	255	50	Filter value for Supply Voltage measurement
40144	RESERVED				
40145	Retrigger Delay (s)	1	1000	10	Reset delay time in seconds when load switch is configured for auto reset
40146	Retrigger Retries	1	100	5	# of retries when Load switch is set for auto reset
40147	BSM Trip Dly (m)	1	480	30	Load Switch disconnect time in minutes after going into low battery saver mode (BSM)
40148	BSM Recovery Dly (m)	0	120	0	Load Switch reconnect time in minutes to reconnect from battery saver mode (BSM)
40149	Enable Off Delay (s)	0	1000	0	(SSR) Solid State Relay Trip Delay time (LOAD CONTROL)
40150	RESERVED				
40151	Modbus Baud Rate	9600	57600	38400	9600, 19200, 38400, 57600



Location	Label	Min	Max	Default	Notes
Read/Write bytes					
<b>40000's</b>	<b>Global Functions</b>				
40152	BSM Low Threshold 24V (*10)	10	400	250	Battery Saver Mode (BSM) low 24V threshold (*10)
40153	BSM Low Threshold 12V (*10)	10	400	125	Battery Saver Mode (BSM) low 12V threshold (*10)
40154	BSM Lo Hyst (V*10)	0	10	1	Voltage Hysteresis for Battery Saver Mode Low (*10)
40155	BSM Hold-Off-Dly (s)	0	1800	10	Delay in seconds before going into low battery saver mode, holdoff to ignore momentary dips in battery voltage caused by starter motors
40156	BSM Hi Threshold 24V (*10)	10	400	310	24 volt system high threshold in Battery Saver mode (*10)
40157	BSM Hi Threshold 12V (*10)	10	400	155	12 volt system high threshold in Battery Saver mode (*10)
40158	BSM Hi Hyst (V*10)	0	10	5	Voltage hysteresis in Battery Saver mode (*10)
40159 to 40198	RESERVED				
40199	Key Command Data	0	65535	0	

#### SPECIFICATIONS:

- OPERATING VOLTAGE: 10-32 VDC
- LOAD CURRENT: 30 AMPS MAX
- OPERATING CURRENT: 30 MILLIAMPS MAX
- CURRENT DRAIN IN BATTERY SAVER MODE: 10 MILLIAMPS MAX
- CURRENT MEASUREMENT AND TRIP ACCURACY:  $\pm(5\%+0.1 \text{ AMP})$
- VOLTAGE MEASUREMENT AND TRIP ACCURACY: 0.2 VOLTS
- AMBIENT TEMPERATURE RANGE: -40°C TO 85°C (-40°F TO 185°F)
- MOUNTING: MOUNTS TO 35MM DIN RAILS
- ENCLOSURE: ABS PLASTIC
- TERMINAL BLOCKS: PLUGGABLE WITH PUSH-IN SPRING-CAGE CONNECTIONS
- SOURCE/LOAD TERMINAL BLOCK: 41 AMPS, 18 TO 8 AWG WIRE SIZES, LOCKING
- CONTROL TERMINAL BLOCK: 20 TO 16 AWG WIRE SIZES
- MODBUS CONNECTIONS: DIN RAIL BUS CONNECTOR
- RS485 SERIAL COMMUNICATIONS: MODBUS RTU, DEFAULT (38400 8N1)
- LOAD CONTROL: ACTIVATED BY PULLING TERMINAL LOW (CONFIGURABLE)
- REMOTE RESET INPUT: ACTIVATED BY MOMENTARILY PULLING INPUT LOW.
- FAULT INDICATION OUTPUT SWITCH: OPEN DRAIN MOSFET CLOSSES TO GND (-) RATED 32 VDC, 200 MA
- STATUS INDICATION OUTPUT SWITCH: OPEN DRAIN MOSFET CLOSSES TO GND (-) RATED 32 VDC, 200 MA
- HAZARDOUS AREA CLASSIFICATION: CLASS I, DIV. 2, GROUPS C & D FOR DIRECT HOOKUP,
- TEMP CODE T3C, MAX. AMBIENT TEMP. 85°C.

**FIGURES SECTION:**

1. MOUNTING DIMENSIONS
2. TIME/CURRENT CURVE TABLE, FAST ACTING
3. TIME/CURRENT CURVE TABLE, SLOW ACTING
4. MINIMUM RECOMMENDED WIRE GAUGE TABLE
5. TOP PANEL DESCRIPTION
6. WIRING DIAGRAM – SOURCE INPUT, LOAD OUTPUT, AND GROUND (-)
7. WIRING DIAGRAM – LOAD CONTROL, REMOTE RESET, FAULT INDICATOR, STATUS INDICATOR, AND RS485
8. WIRING DIAGRAM – RS485 SERIAL COMMUNICATIONS

FIGURE 1. MOUNTING DIMENSIONS

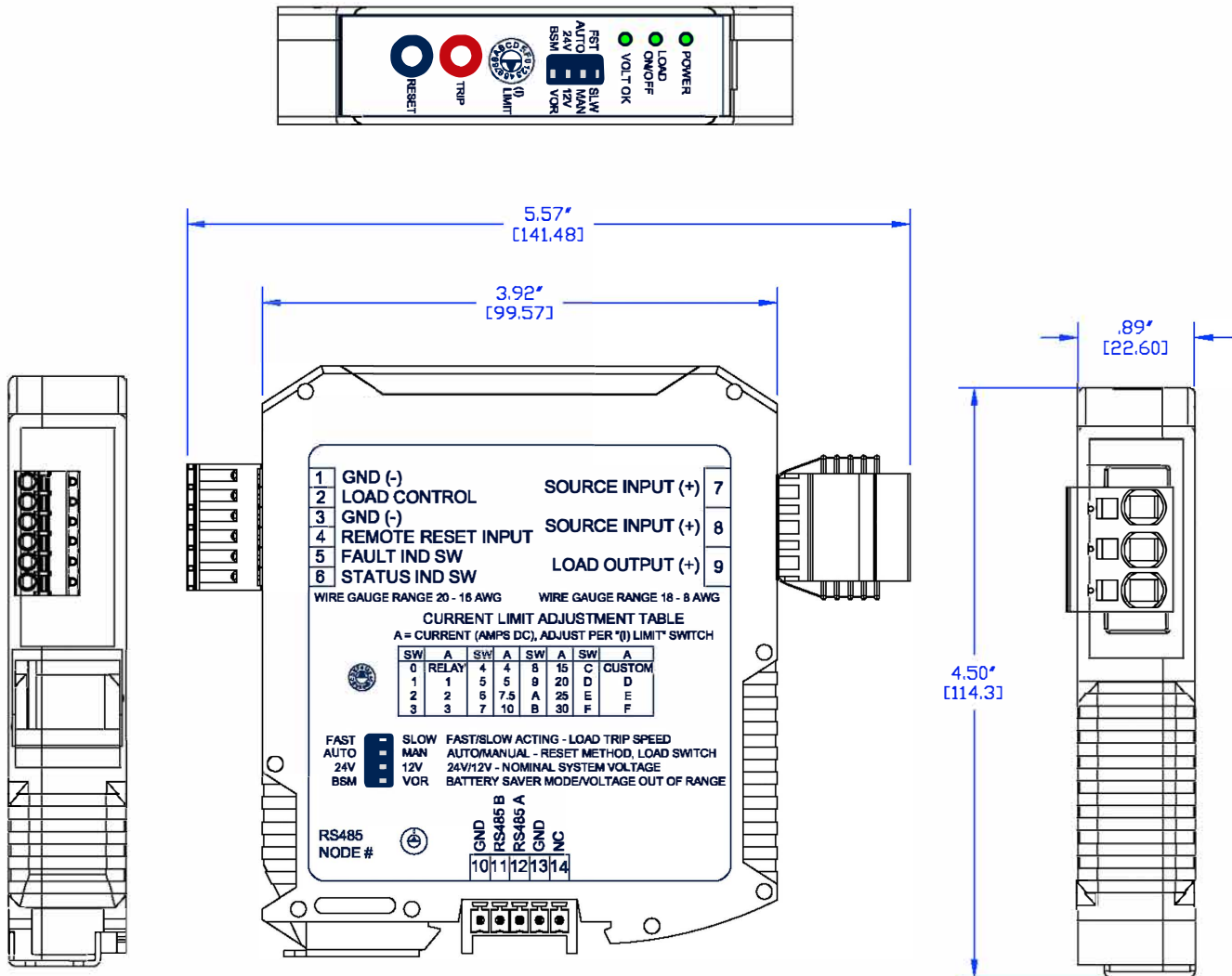

**NOTE:** MOUNT TO A 35MM DIN RAIL IN A SUITABLE ENCLOSURE. STRIVE TO MOUNT WITH TERMINALS 7, 8, AND 9 UP TO ALLOW FOR BEST HEAT DISSIPATION OUT OF THE MODULE WITHOUT TRAVELING THROUGH IT.

FIGURE 2. TIME/CURRENT CURVE TABLE, FAST ACTING

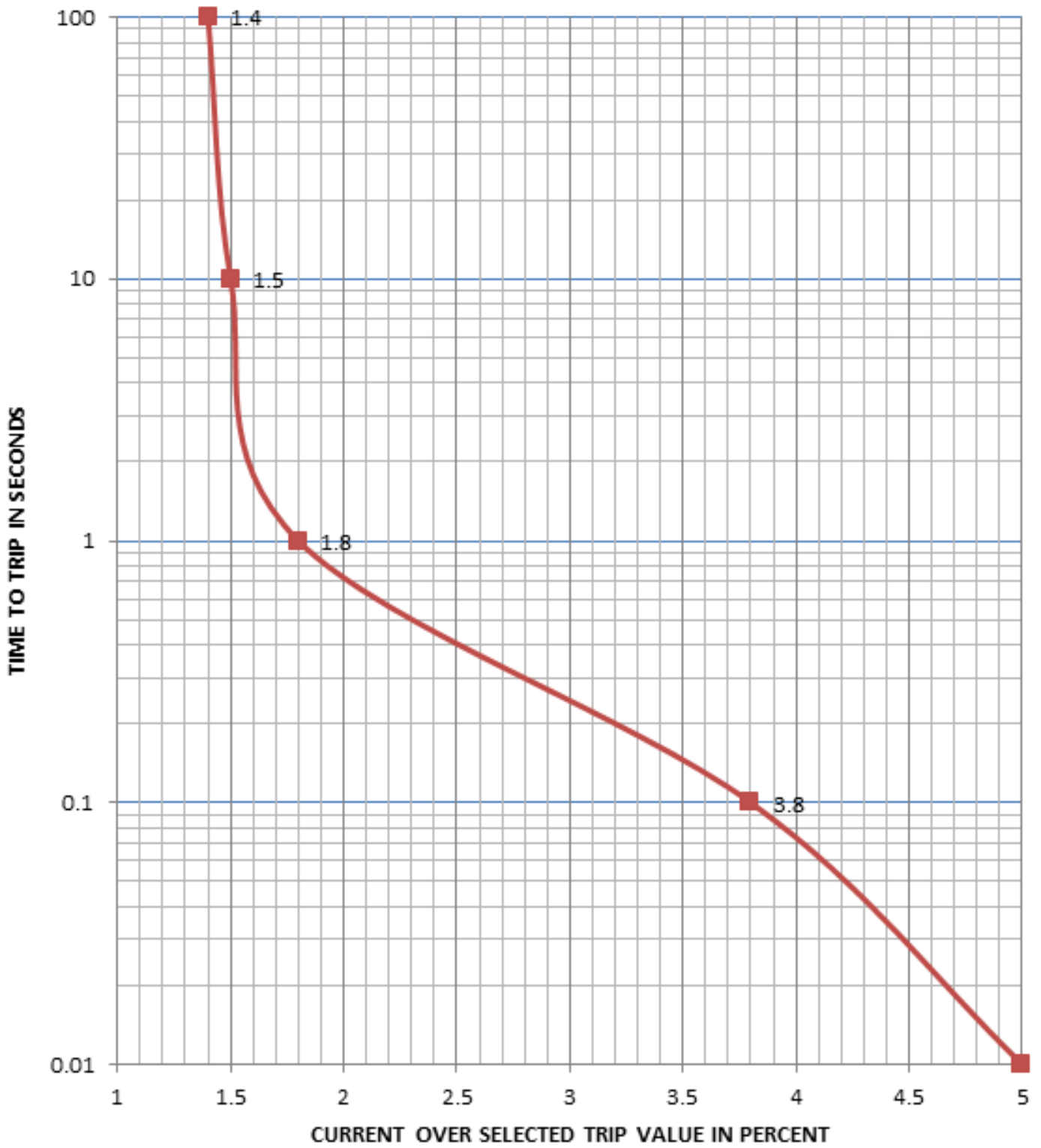

FIGURE 3. TIME/CURRENT CURVE TABLE, SLOW ACTING

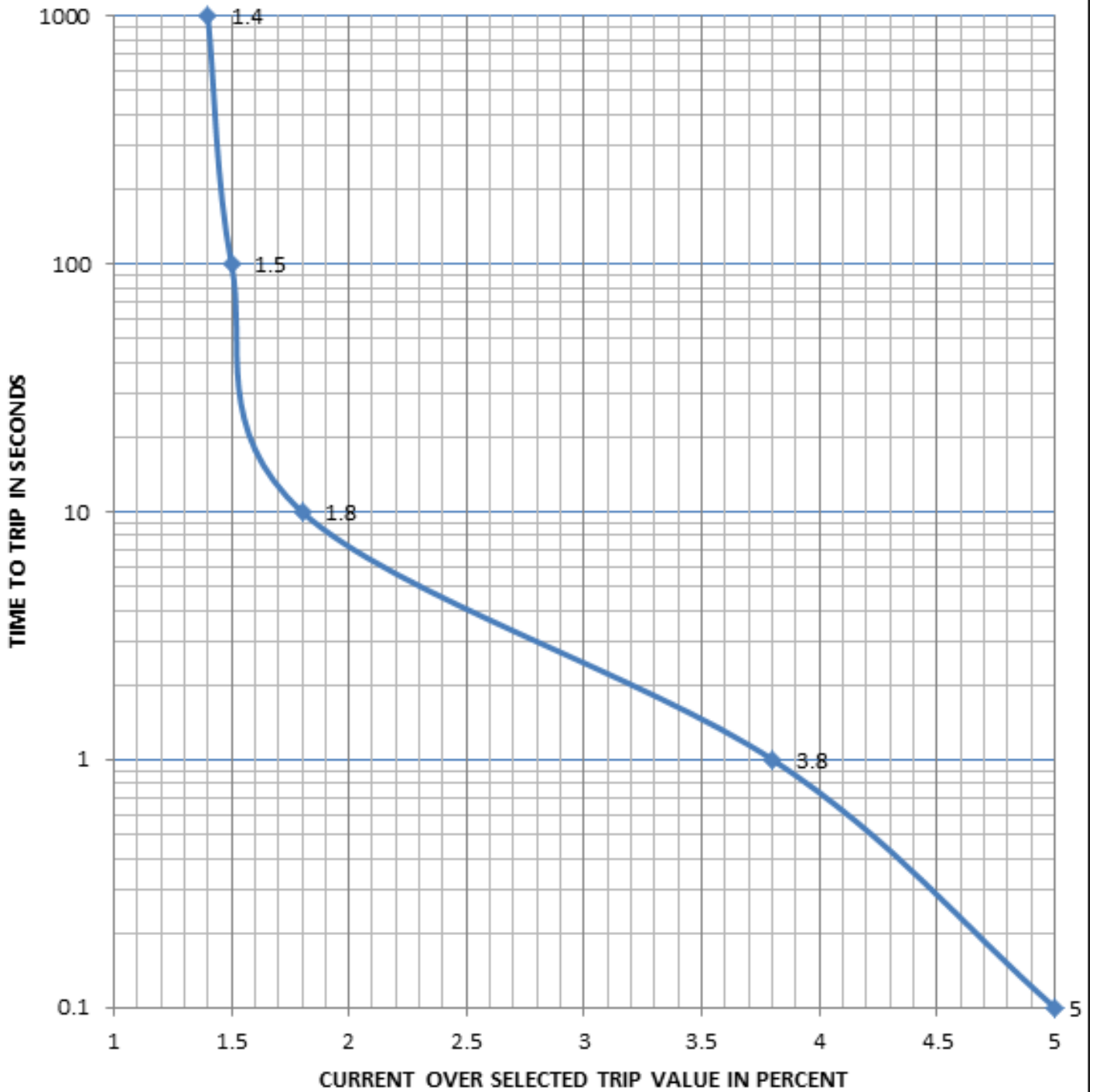
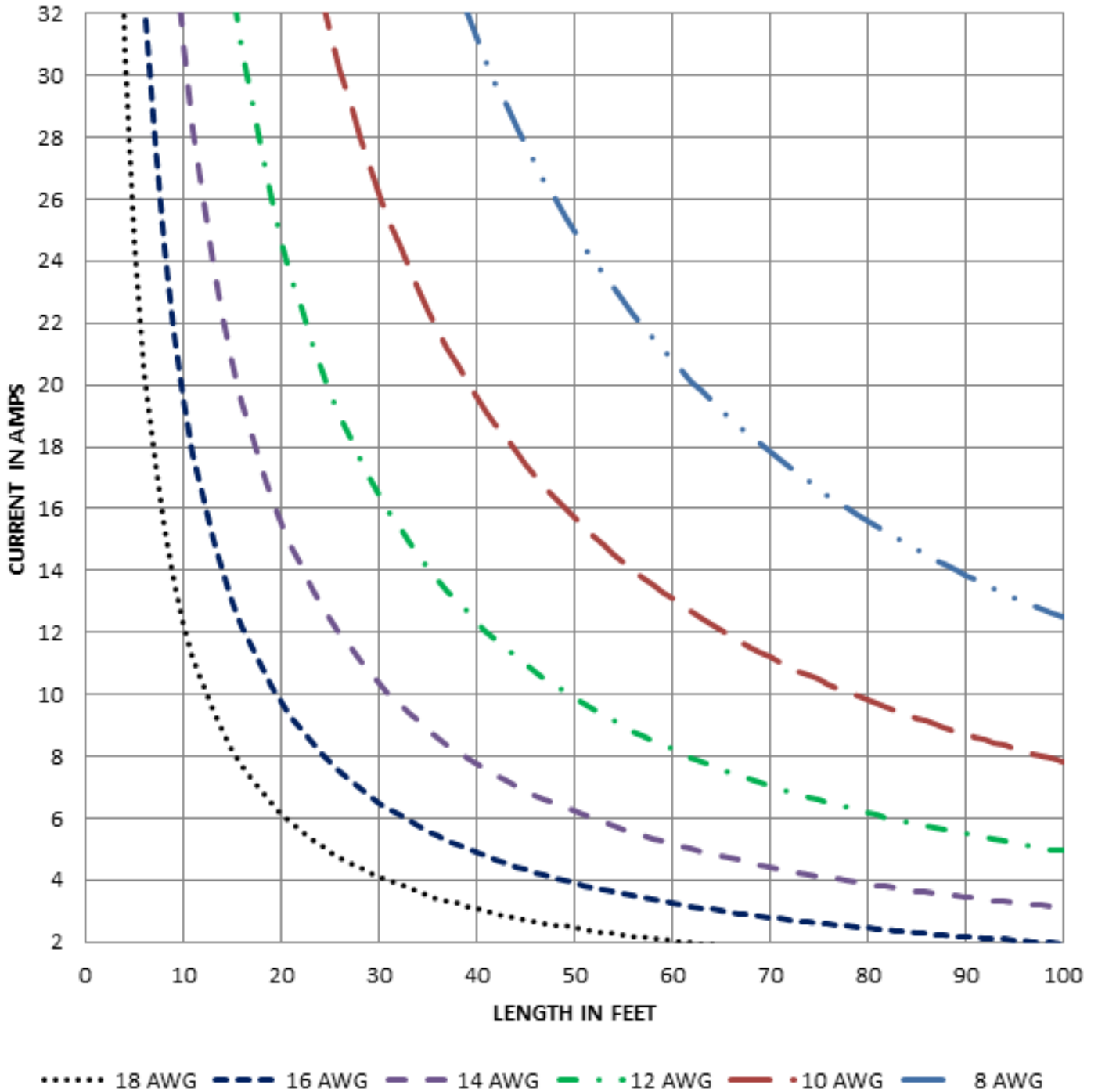
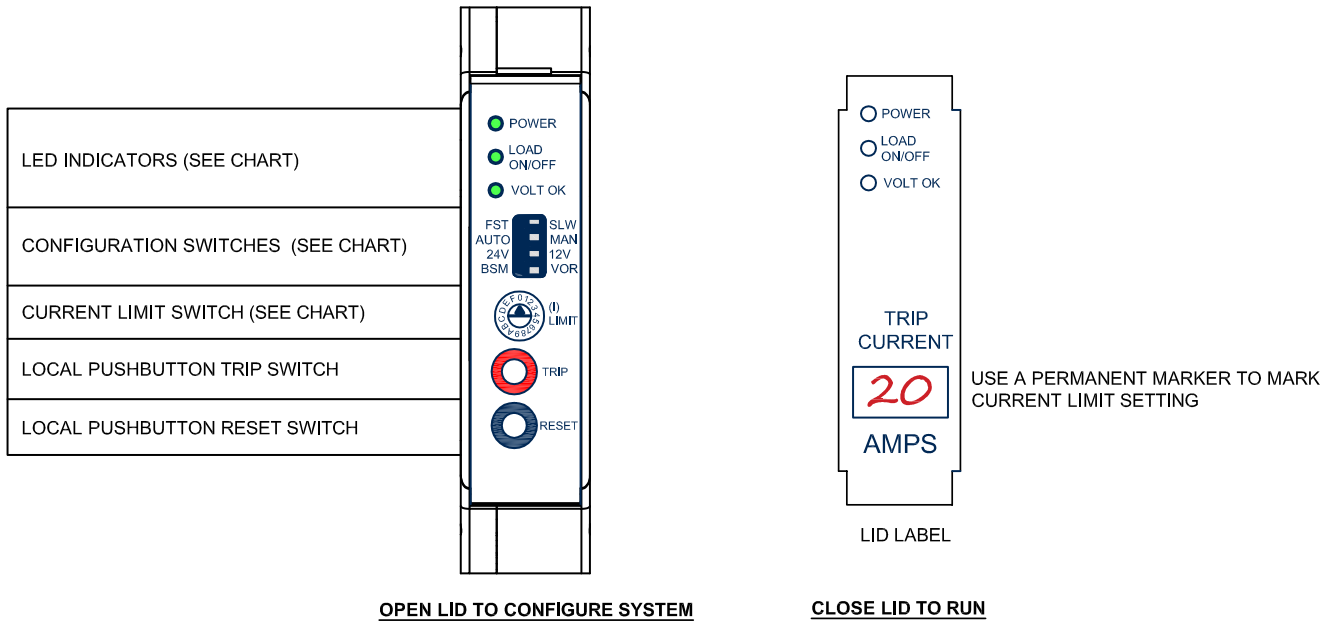

FIGURE 4. MINIMUM RECOMMENDED WIRE GAUGE TABLE

**FOR LOW VOLTAGE (28 VOLT) SYSTEMS**



**FIGURE 5. TOP PANEL DESCRIPTION**



LED Indicators			
LED	Green	Blinking	Red or Off
Power	Module Is Powered	In Battery Saver Mode	No Power
Load ON/OFF	Load Is Connected To Source	Above Set Value But Not Tripped	Open Load
Volt OK	Input Voltage Within Range	Below BSM Setpoint	Voltage Out of Range

Current Limit Chart	
SW Pos	Trip Current (amps)
0	SS Relay
1	1
2	2
3	3
4	4
5	5
6	7.5
7	10
8	15
9	20
A	25
B	30
C	Custom
D	Custom
E	Custom
F	Custom

Configuration Switches				
SW	Function	Description	Switch Position	
			Left	Right
1	Fast/Slow Acting	Load Trip Time	Fast	Slow
2	Auto/Manual Reset	Load Switch Reset Type	Auto	Manual
3	24/12 volt	System Voltage (nominal)	24V	12V
4	BSM/VOR	Battery Saver Mode or Voltage Out of Range	BSM	VOR

FIGURE 6. WIRING DIAGRAM – SOURCE INPUT, LOAD OUTPUT, AND GROUND (-)

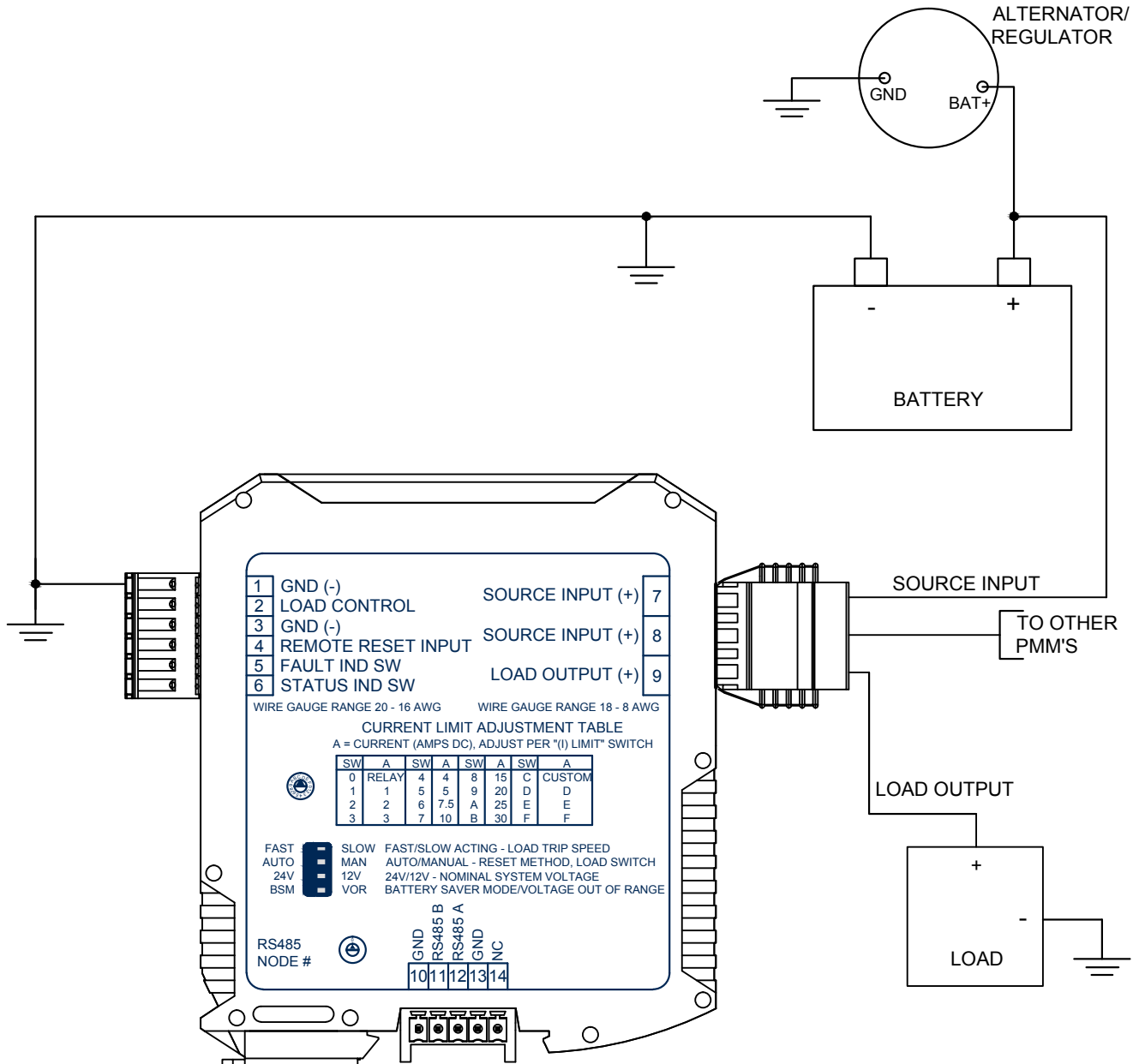

NOTES:

1. TERMINAL 1 GND(-) MUST BE TIED TO BATTERY/ POWER SUPPLY MINUS (-) FOR PROPER OPERATION.
2. WHEN USED WITH HIGHER LOADS STRIVE TO MOUNT THE MODULE WITH THE SOURCE AND THE LOAD TERMINAL UP. THIS WILL ALLOW FOR THE BEST HEAT DISSIPATION OUT OF THE MODULE WITHOUT TRAVELING THROUGH IT.



**FIGURE 7. LOAD CONTROL, REMOTE RESET, REMOTE FAULT INDICATOR, REMOTE STATUS INDICATOR, AND RS485**

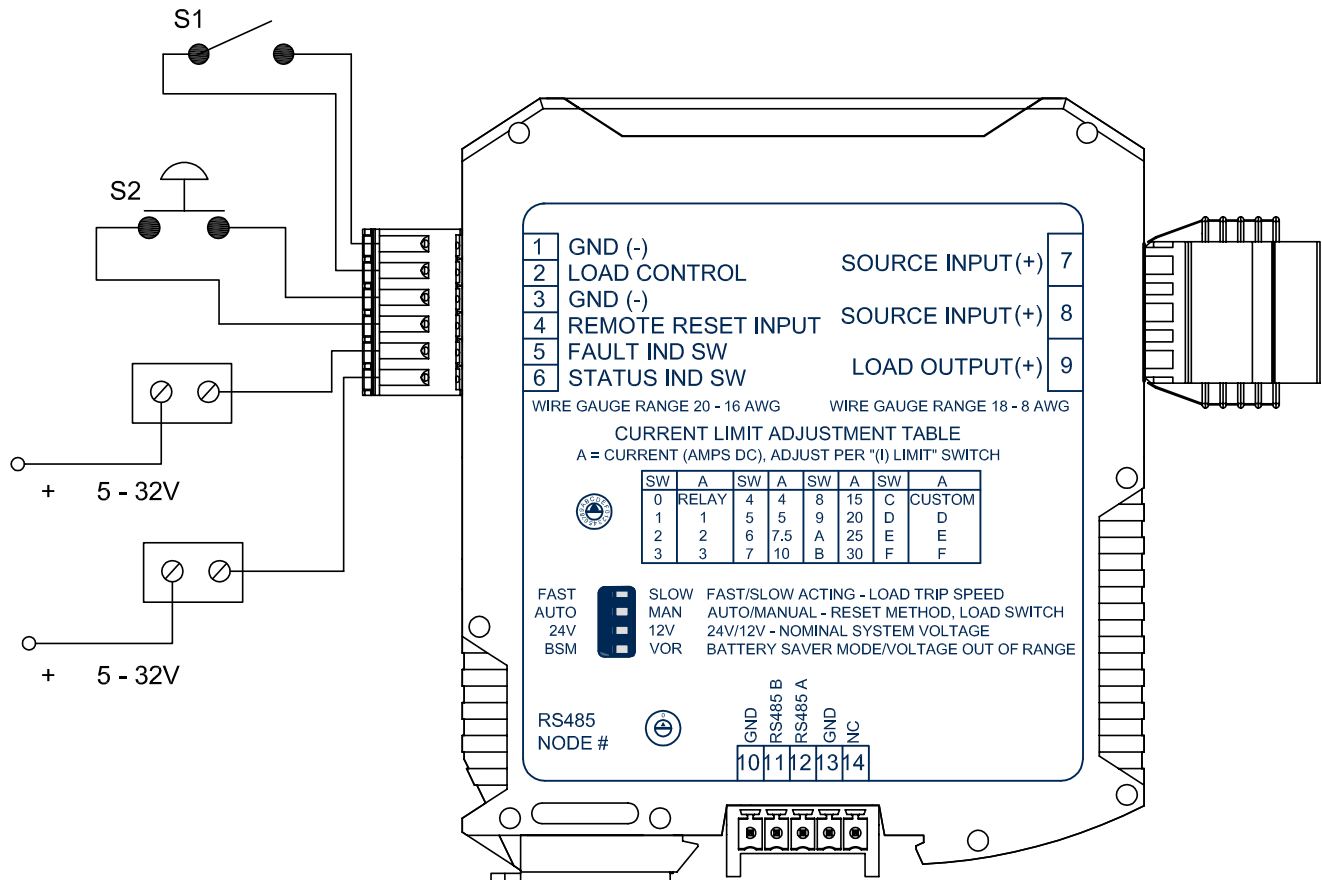

**NOTES:**

1. S1 IS AN INPUT. CLOSE S1 (OR OPEN BY CONFIGURATION CHANGE) TO DISCONNECT THE LOAD FROM THE SOURCE.
2. S2 IS A MOMENTARY SWITCH THAT WHEN CLOSED TO GROUND (-) PERFORMS A RESET.
3. TERMINAL 5, REMOTE FAULT INDICATION SWITCH, TURNS ON TO GND (-) WHEN THE LOAD IS DISCONNECTED FROM THE SOURCE (-) BY THE PMM. THE FAULT SWITCH IS AN OPEN DRAIN MOSFET RATED 32 VDC, 200 mA MAX.
4. TERMINAL 6, REMOTE STATUS INDICATION SWITCH, TURNS ON TO GND (-) TO INDICATE WHEN THE PMM ENTERS BATTERY SAVER MODE. THE STATUS SWITCH IS AN OPEN DRAIN MOSFET RATED 32 VDC, 200 mA MAX.

**FIGURE 8. WIRING DIAGRAM - RS485**

