

INSTALLATION/OPERATION

VSM VIBRATION SENSING MONITOR

FORM VSM IOM 1-09

**WARNING:**

DEVIATION FROM THIS INSTALLATION/OPERATING MANUAL MAY LEAD TO IMPROPER OPERATION OF THE MONITORED MACHINE WHICH COULD CAUSE PERSONAL INJURY TO OPERATORS OR OTHER NEARBY PERSONNEL.

**CAUTION:**

THE VSM VIBRATION MONITOR IS CERTIFIED FOR USE IN CLASS I, GROUPS C & D, DIVISION 2 HAZARDOUS LOCATIONS WHEN INSTALLED IN ACCORDANCE WITH THESE INSTRUCTIONS.

THE SENSOR INPUT LEADS CONNECTED TO THIS DEVICE OPERATE AT A LOW VOLTAGE AND POWER LEVEL AND MUST NOT CONTACT ANY EXTERNAL VOLTAGE SOURCE. DAMAGE TO THE SYSTEM WILL RESULT FROM CONNECTION BETWEEN THE INPUT SENSOR LEADS AND THE IGNITION SYSTEM OR ANY AC OR DC POWER SOURCE ABOVE 36 VDC.

1.0 DESCRIPTION

1.1 The Altronic **VSM Vibration Monitor** is a **32-bit** microprocessor-based electronic instrument designed to protect industrial engines, compressors, and associated equipment from damage caused by excessive vibration. The monitor accepts up to **4 (VSM-400)** or **8 (VSM-800)** industry-standard low-cost, broadband, piezoelectric vibration sensors that are used to transform mechanical vibrations into electrical signals which are then evaluated by the **VSM**. The resulting vibration levels are displayed on a LCD display and are compared to user adjustable setpoint levels (**2** per channel). If a high vibration level surpasses a setpoint value an indication is shown on the LCD and an output switch, one for alarm and one for shutdown, is activated. The **VSM** has a **RS485** Modbus RTU communications link. The integral **RS485** port allows the monitored values and status of all channels to be communicated to a PC, PLC, or other communications device. The **VSM** allows for a start-up lockout time for each channel during machine startup as well as remote reset.

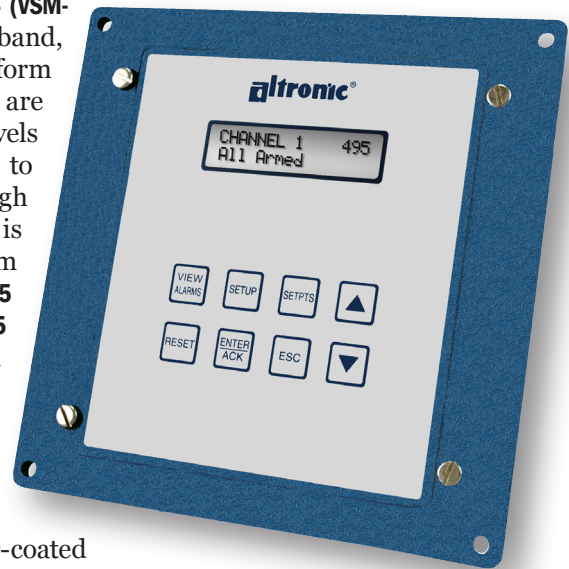

1.2 The **VSM** is housed in a **6.5" x 6.5"** rugged powder-coated aluminum case. The user interface is an **8-key** membrane keypad along with a **2x16** backlit LCD. Rugged, pluggable Phoenix-type connectors are used for all connections. The power requirement is **10 to 32Vdc, 0.20Amp** max.

1.3 Each channel of the **VSM** is easily configured (user customized) for each sensor point using the keypad. No terminal programming is required.

1.4 For proper operation, these instructions must be adhered to strictly.



CERTIFIED CLASS I,
DIVISION 2
GROUPS C AND D

VSM-400/VSM-800 VIBRATION MONITOR

2.0 APPLICATIONS

2.1 The **VSM** is designed to be used on any rotating or reciprocating equipment including but not limited to the following:

- ENGINES
- COMPRESSORS
- COOLING TOWERS
- TURBOCHARGERS
- MOTORS
- GEAR BOXES
- PUMPS
- FANS

NOTE: *If possible, keep the original shipping container. If future transportation or storage of the monitor is necessary, this container will provide the optimum protection.*

3.0 VIBRATION SENSORS

3.1 The vibration sensors convert the monitored vibrations to electrical signals that are then used by the **VSM** to measure the amplitude of the vibration. The sensors are of the low-cost, automotive, broadband piezoelectric type. In order to use these signals properly, the sensors must be securely bolted to the monitored surface at their optimum locations (see mounting section below and **FIGURES 3, 4A, AND 4B** for further sensor application information). The vibration sensor suggested for use with the **VSM Vibration Monitor** is the **Bosch P/N 0 261 231 148**. Equivalent models from other manufacturers may also be used. The Bosch sensor is available from Altronic as **P/N 615107**. The cable assembly is **P/N 693134-x**.

Description	Part Number
Vibration Sensor	615107
Cable Assembly, 10'	693134-1
Cable Assembly, 20'	693134-2
Cable Assembly, 30'	693134-3
Cable Assembly, 40'	693134-4
Cable Assembly, 50'	693134-5
Cable Assembly, 100'	693134-6

4.0 MOUNTING

4.1 VIBRATION SENSING MONITOR (SEE FIGURE 1)

Mount the **VSM** inside a control panel or to a suitable flat surface so that the display is at a convenient viewing height. A drilling template is provided.

NOTE: *Avoid mounting the Monitor with the LCD display facing direct sunlight. The display temperature range is -22°F to +175°F (-30°C to +80°C).*

4.2 VIBRATION SENSORS (SEE FIGURES 3, 4A AND 4B)

The location and mounting procedure of the vibration sensors are dependent on the machine to be monitored.

4.2.1 LOCATION

Locate the sensors with the mounting bolt perpendicular to the axis of rotation, close to the bearing housing of the monitored equipment. The most effective point is normally found to be close to the centerline of the crankshaft, fan shaft, coupling, or bearing, depending on the monitored machine. The sensors should be mounted at locations where exposure to liquids such as gasoline, antifreeze, oil, brake fluid, etc., is minimal. Angular mounting position is arbitrary.

4.2.2 MOUNTING PROCEDURE

Mount the vibration sensors to a smooth, flat surface on the vibrating part. A surface that is not smooth will give erratic readings. Drill and tap the location perpendicular to the surface, counterbore if necessary. Use a bolt of **M8x25, grade 8.8**. Make sure the bolt does not bottom-out in the tapped hole. Torque the bolt to **20 ± 5Nm (15 ± 1Ft/Lb)**. Do not over-tighten, damage may occur to the sensor. No washer of any kind is permissible. Only the metallic part of the sensor (**φ 22mm**) may make contact with the surface.

NOTE: Altronic HIGHLY RECOMMENDS the use of resistor spark plugs and/or spark plug leads with all digital instrumentation as a means of reducing the impact of RFI (radio frequency interference) on operation.

5.0 WIRING (SEE WIRING DIAGRAMS)

5.1 GENERAL

Take care not to damage the insulation and take precautions against damage from vibration, abrasion or liquids in conduits. Never run sensor, low voltage power, current loop, communications, or output switch wires in the same conduit as the ignition wiring or other high energy wiring such as AC line power, etc. Keep wires at least **12** inches away from all high voltage wiring.

Keep secondary wires to spark plugs and other high voltage wiring at least **12 inches (205mm)** away from vibration sensors and their wiring.

5.2 POWER WIRING

Connect the power input wires to terminals (**DC+**) and (**DC-**); power requirement is **10 to 32Vdc, 0.20Amp max**. Connect the minus terminal (**DC-**) to panel ground, which must be the same as the ground on the monitored device.

DO NOT CONNECT THE MINUS TERMINAL DIRECTLY TO AN IGNITION SYSTEM COMMON COIL GROUND ON THE ENGINE.

5.3 VIBRATION SENSOR WIRING

The vibration sensors generate low voltage bipolar signals in the millivolt range. Mount the sensors as described above. Each vibration sensor requires two wires. Use a two-conductor cable of **20-22AWG** (Altronic **693134-x** or equivalent) to wire the vibration sensor to the sensor input terminals on the back of the **VSM**. The sensor cables should be run in rigid conduit or Sealtite/Liquidtite to protect the wires from breakage. The shield wire can be grounded on one end if it is determined that spurious electrical noise is affecting sensor output.

5.4 OUTPUT SWITCH WIRING

Exceeding a setpoint value will cause the user-programmable output switch to turn **ON/OFF** with respect to its common. The **VSM** contains two output switches. Switch **1** is typically used for alarm and switch **2** is typically used for shutdown. Output switch **1** will trip when an input value exceeds its alarm setpoint value. Output switch **2** will trip when an input value exceeds its shutdown setpoint value. These switches are solid state, form C (N/O and N/C) break-before-make contacts and are isolated from the power supply. Switch **1** is closed with the absence of power and switch **2** is open with the absence of power. The switches are rated at **32Vdc, 200mA** and the N/O switch has a unique internal overload current protection circuit. If an overload occurs, the internal circuitry limits current to safe levels. When the overload is removed, the relay resumes its normal **ON** characteristics. These switches can be wired to engine management systems, an Altronic annunciator system or to pilot duty relays as shown by the wiring diagrams.

5.5 RS485 COMMUNICATIONS WIRING

The **VSM** can communicate to other instruments, PC's or PLC's via the two serial **RS485** communication wires. Use a two-conductor shielded cable of fine gauge stranded wire and connect the wires to the terminals marked **RS485 A** and **RS485 B**. Make the following connections to the other communication device **A** to **A(-)** and **B** to **B(+)**. If required, connect the shield wire to the master device only.

5.6 HAZARDOUS AREA OPERATION

The **VSM** is **CSA certified** for **CLASS I, DIVISION 2, GROUPS C & D** areas as a component only and is required to be installed in a suitable enclosure where the suitability of the combination is subject to the local inspection authority having jurisdiction. The power connections to the **VSM** must be in accordance with the **National Electrical Code** and in Canada, the **Canadian Electrical Code**. In addition, the following requirements must be met:

1. **Run the sensor wires leaving the panel in a separate conduit from all other wiring and keep them separate throughout the installation.**
2. **Power, input, and output wiring must have a grade of insulation capable of withstanding an AC voltage of 500 volts RMS.**
3. **In general, run wires in separate conduits and junction boxes from high voltage wires such as ignition, fuel valve, and other high voltage wiring.**



**WARNING
EXPLOSION
HAZARD:**

**DO NOT DISCONNECT EQUIPMENT IN DIV. 2 ENVIRONMENT
UNLESS POWER IS SWITCHED OFF OR THE AREA IS KNOWN
TO BE NON-HAZARDOUS.**

5.7 TESTING SENSOR LEADS

If it becomes necessary to check sensor-to-terminal wiring with an ohmmeter or other testing device, first disconnect the sensor wires from the monitor. This will prevent possible damage to the device's sensitive low voltage detection circuitry.

6.0 OVERVIEW

- 6.1** The **VSM** senses shock and vibration from the remote mounted vibration sensors and displays a velocity amplitude number on the LCD in the range of 0 to **999**. The velocity amplitude number displayed is unit-less and in this manual is referred to as the vibration reference number.
- 6.2** The **VSM** vibration sensor is an automotive type accelerometer. It generates a low voltage signal proportional to vibration intensity. The sensor inputs to the **VSM** are differential and are not referenced to ground.
- 6.3** Each channel can have its own unique label used to describe the monitored point. There are several commonly used labels available in the monitor that are accessible through the **SETUP** menu.
- 6.4** Each channel can be configured differently from the others with its own unique alarm and shutdown setpoint value, startup delay timer value, sensor gain value, and trip delay time value.
- 6.5** There are two output switches, switch **1** is for alarm and switch **2** is for shutdown. Switch **1** is normally closed and switch **2** is normally open with lack of power. These switches are isolated from ground and turn-on to switch common.

7.0 INITIAL OPERATION

- 7.1** Upon power-up, the monitor will display a splash screen showing the model number and firmware version. The display will then proceed to display the vibration level for channel **1**.
- 7.2** The **VSM** is shipped with factory defaults that allow for an initial display of each channel's vibration level. Although vibration levels are displayed, each application is unique and configuration must be performed. **SEE SECTION 11.0 CONFIGURING THE VSM** for proper system configuration.

8.0 KEYPAD DESCRIPTION

8.1 The **VSM Vibration Monitor** contains a front keypad which is used to view reference data, view and change the setpoint values, view the diagnostic data, and to access the menu. The eight front panel keys are **VIEW ALARMS**, **RESET**, **SETUP**, **ENTER/ACK**, **SETPTS**, **ESC**, **▲**, and **▼** (up and down arrow keys).

8.2 VIEW ALARMS

The **VIEW ALARMS** key allows the user to view the alarms occurring when either switch #1 or switch #2 trips. Pressing **VIEW ALARMS** displays the alarms that occurred when a switch tripped. Each occurrence is displayed in order, last to first. Additional key presses will show further occurrences. Each occurrence will appear once in the list. After displaying all of the captured occurrences, the display will ask **CLEAR LOG?**. Select **YES** and **ENTER** to clear the logs, **NO** to retain them. If no occurrences are logged, the display will show **NO ALARMS**. Press **ESC** to return to the home screen.

8.3 RESET

The **RESET** key clears the output switch(es) and resets the startup timers.

8.4 SETUP

The **SETUP** key is used to scroll through the **Setup** menu.

8.5 ENTER/ACK

The **ENTER/ACK** key is used to save new data or a new configuration in nonvolatile memory. The setup will remain even through power-down. The **ENTER/ACK** key is also used to acknowledge alarms and to cancel the start-up timer.

8.6 SETPTS

The **SETPTS** (setpoints) key is used to view or change the setpoint values. **REFER TO SECTION 10.0** for more information.

NOTE: The setpoints cannot be changed if the protection is set to **On**.

8.7 ESC

The **ESC** (escape) key can be used at any time during the setup, setpoint or view alarm modes to return to the home screen. When the **ESC** key is pressed in any configuration mode, any changed values are ignored (not stored in memory), the configuration returns to the previous values, and the display returns to the home screen. The **ESC** key is also used to toggle between the numerical and graphical home screens.

8.8 ▲ ▼

The up and down arrow keys are used to increment or decrement the displayed channel number and corresponding reference number. Each press of the up arrow key increments the channel one at a time while the down arrow key decrements it. These keys also scroll through the selections in the setup menu and are used to increase or decrease values for setpoints and setup values.

9.0 HOME SCREEN DESCRIPTION

When the **VSM Vibration Monitor** is in the **Home Screen**, it displays the channel number (or channel label when configured), along with the channel number's vibration reference level on the first line. The second line is used as a status line.

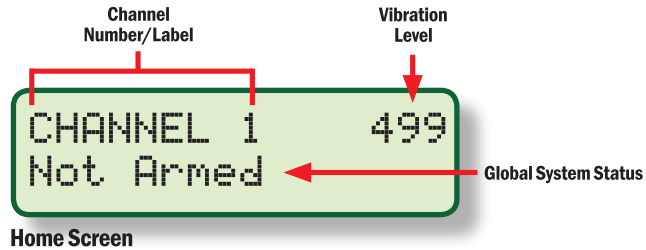

Use the ▲ or ▼ (up/down arrow keys) to scroll through the channels.



9.1 SYSTEM STATUS

The second line of the display shows the global status of the **VSM** system. The system status descriptions are:



Not Armed is displayed when the startup lockout line is grounded. **Not Armed** indicates that the output switches are locked out or disabled. Vibration levels will be displayed, but if they are above the setpoints the outputs will remain unchanged. This is used during engine/machine startup to prevent undesired alarms or shutdowns.

VSM-400/VSM-800 VIBRATION MONITOR

```
CHANNEL 1      495  
Timer 60s
```

TIMER XXs is displayed upon the release of the startup lockout line. The timer shows the remaining time before the outputs become active for the displayed channel. The **VSM** is operating in monitor mode. The output switches are locked out until the timer expires. This allows the engine/machine to start and stabilize without either of the output switches interfering with engine/machine start-up and loading.

```
CANCEL TIMERS?  
↑↓ NO
```

CANCEL START-UP TIMERS: To cancel start-up timers, press **ENTER/ACK** when a start-up timer is active. The display will read as above. Use the **UP** or **DOWN** arrow key to display **YES** and press **ENTER**. All of the start-up timers will be cancelled, enabling the output switches.

```
CHANNEL 1      495  
Ch Armed
```

ARMED indicates the channel being viewed is in normal operation mode. The **Control Lockout Time** has expired on the displayed channel. The vibration from that sensor is being compared to the setpoint values and the output switch will take effect if the setpoint values are exceeded.

```
CHANNEL 1      495  
All Armed
```

ALL ARMED indicates all of the channels are in normal operation mode. **The Control Lockout Time** has expired on all channels. The vibration from all of the sensors are being compared to their setpoint values and the output switch(es) will take effect if the setpoints are exceeded.

```
CHANNEL 1      650  
Alarm: 1
```

ALARM: 1 is displayed when the viewed channel's vibration amplitude level is continuously above the **Alarm** setpoint value.

```
CHANNEL 1      795
Alarm: 1 2
```

ALARM: 1 2 is displayed when the viewed channel's vibration amplitude level is continuously above both the Alarm setpoint value and the Shutdown setpoint value.

```
CHANNEL 1      795
Alarm
```

ALARM is displayed when a channel other than the viewed channel's vibration amplitude level is above either the **Alarm** or **Shutdown** setpoint value.

```
CHANNEL 3      5
Bad Sensor sw1
```

ENTER
ACK

BAD SENSOR is displayed if a sensor is determined to be open or shorted on a configured input. If **Output Switch #1** is configured to trip on a bad sensor condition, **SW 1** will appear on the second line indicating that **Switch #1** is activated. Press the **ENTER/ACK** key to acknowledge the condition. **SW2** will appear if **Switch #2** is configured to trip on a bad sensor condition.

```
CHANNEL 4      500
View Alarms
```

ENTER
ACK

VIEW ALARMS – When a setpoint value is violated the **View Alarms** message will blink alternately with the system status message. Press the **ENTER/ACK** key to acknowledge the condition. Press the **VIEWALARMS** key to view the Alarms message to see what caused the alarm or shutdown. **SEE SECTION 12.0** for further information on the **View Alarms** feature.

9.2 BARGRAPH



A bargraph screen showing each configured channel's vibration reference level in graphic form and whether an **Alarm A**, **Shutdown S**, or **Bad Sensor B** setpoint has been violated, is shown on the bottom row of the display. The top row remains the same. The bargraph screen is also considered a home screen. It can be used as a quick overview of each channel's current condition. The graph is shown in channel order. Each vertical bar is a channel starting with channel **1** on the left. Only the configured channels are shown. To view the bargraph, press the **ESC** key from the numeric home screen. Press the **ESC** key again to return to the numeric home screen. There is no time-out for the bargraph screen; it will remain until **ESC** is pressed. The bargraph screen shown above is configured for **8** channels.

9.3 RESET



Reset can be initiated in one of three ways: by pressing the **RESET** key, by pulling the remote reset terminal on the back of the monitor low, or by sending a reset command via the **RS485** communications. Pressing **RESET** from the home screen resets the **Start Up Timer** and places the output switches in the non-tripped condition. When the reset key is pressed, the display will show **PERFORM RESET?**. The default is **NO**. Use the up or down arrow key to select **YES** and press **ENTER**.

9.4 STARTUP LOCKOUT

The **Startup Lockout** terminal on the back of the monitor is used to lock out the **Alarm** and **Shutdown** output switches from tripping during machine startup when above normal vibrations may occur. The output switches are locked out or disabled when the terminal is low or grounded. For an engine compressor application this terminal can be wired to the **Altronic DE-3000 Controller System** to a discrete switch on the terminal module. Program the **DE-3000** digital output switch as an **S01** analog control setting with a low setpoint of **50**, and wire the startup lockout of the **VSM** to this discrete switch. Another option would be to wire this terminal to an oil pressure switch. For loss of oil pressure the switch should be grounded.

When the terminal is released, (ungrounded) the **Start Delay Timer** for each channel commences. The output switches will remain locked-out for each individual channel until the timer for each channel ends. Each channel will become armed as the timer for that channel expires. The start-up timers' remaining time will be displayed on the display for each channel. Upon completion the display will show **ARMED**. When all of the timers expire, the display will show **ALLARMED**.

10.0 SETPOINTS

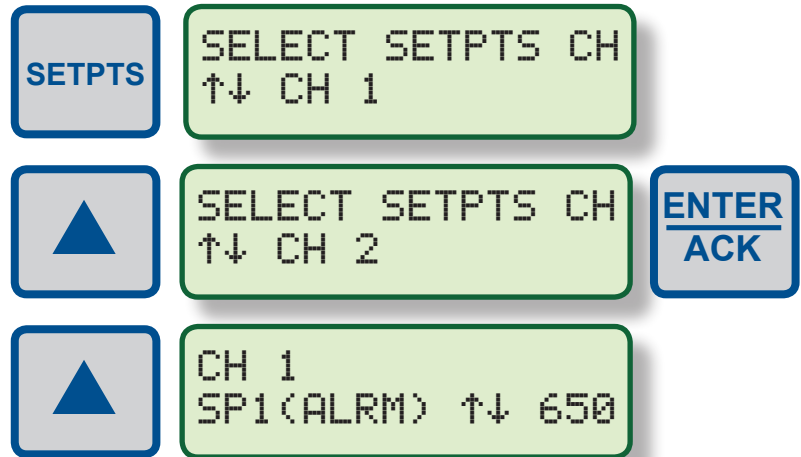

NOTE: When configuring the setpoints, the **ENTER** key must be pressed within 30 seconds to save the new value. If no key is pressed for 30 seconds, the display will return to the home screen and the previous setpoint value will be reinstated.

Use the setpoint menu to adjust the **ALARM**, **SHUTDOWN** and **BAD SENSOR** setpoints. From the home screen, press the **SETPTS** key to access the setpoint menu. Press the **▲** or **▼** (up/down arrow keys) to select a channel and press **ENTER**. Use the **▲** or **▼** (up/down arrow keys) to adjust the setpoint value. Press **ENTER** to save the value. The LCD will show **SAVED** and return to the current screen. Press the **SETPTS** key to access **SP2** and **BAD SENSOR** setpoints. Press **ESC** to adjust the setpoint values for the other channels. Press **ESC** again to return to the home screen. To turn a setpoint to off, press both the **▲** and **▼** (up/down arrow keys) together.

10.1 ALARM AND SHUTDOWN

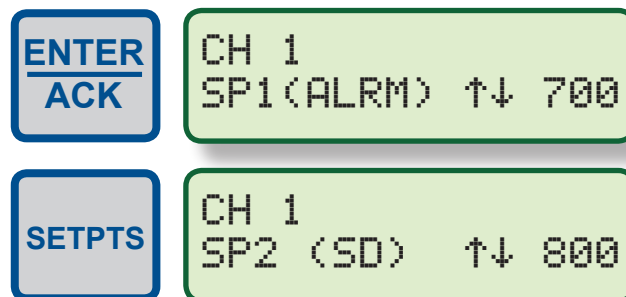

The **ALARM** and **SHUTDOWN** setpoints are high setpoints. If the vibration level goes above the alarm setpoint, switch #1 will activate. If the vibration level goes above the shutdown setpoint, switch #2 will activate. Each setpoint can be set anywhere within the range of the monitor, or off. To turn a setpoint off, press both **▲** and **▼** (up and down arrow keys) simultaneously, press **ENTER** to save.

10.2 BAD SENSOR

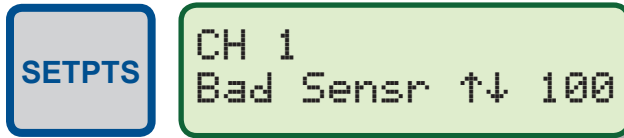

The **Bad Sensor** setpoint value is a user-configurable, low vibration setpoint value. It is used to trigger the **VSM** to take action if the sensor or its wiring channel goes open or shorted. A bad sensor will cause the input to go low. When the reference number goes below the bad sensor setpoint value, the monitor will register a bad sensor. Either output switch **#1** or **#2** can be configured to take action. (**SEE SECTION 11.14 BAD SENSOR SWITCH SELECTION** on how to select either switch **#1** or **#2**). The range of the bad sensor setpoint level is **0 to 999**, or off, and should be below the alarm setpoint value, but above zero. Each channel has its own configurable setpoint value. The default value for a bad sensor is **50**. The value entered should be fine-tuned when on a live engine.

11.0 CONFIGURING THE VSM



WARNING: THE VSM VIBRATION MONITOR MUST BE CONFIGURED PRIOR TO USE.

11.1 OVERVIEW

Since operating conditions differ, the **VSM Vibration Monitor** must be customized for each application. Each parameter is described below. The configuration parameter values must be carefully chosen.

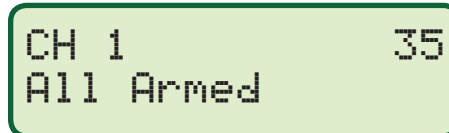

To configure the **VSM**, press the **SETUP** key to enter the menu from the home screen (SEE FIGURE 2 for a flowchart that shows step-by-step progression through the monitor's menu). Press the **SETUP** key to progress through the menu. Where arrows \updownarrow are shown, use the \blacktriangle or \blacktriangledown arrow keys on the keypad to increase or decrease values or to scroll through the selections. After making a change, press the **ENTER** key to save the configuration to memory; the display will read **SAVED**. It is at this time that the new data is saved. The **ESC** (escape) key can be used at any time to abort the menu and return to the home screen. During configuration, the gauge allows **30** seconds between keystrokes to change or save a new configuration. If the time lapses without a keystroke, the monitor will automatically return to the home screen without making any changes.

11.2 AUTOSCAN

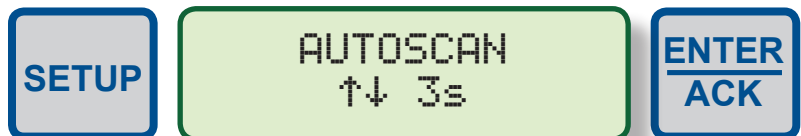

AUTOSCAN configures the display to scroll automatically between the configured channels. Autoscan can be set from **1** to **30** seconds or **OFF (0)**. With **AUTOSCAN** turned on, when in the home screen, the gauge will display each channel for the selected time period before automatically switching to the next channel. The \blacktriangle arrow key can be used to quickly advance to the next channel. With **AUTOSCAN** turned **OFF**, the scanner continually displays one channel at a time. Press the \blacktriangle arrow key to display the next channel. Press the \blacktriangledown arrow key to display the previous channel.

11.3 FACTORY DEFAULTS

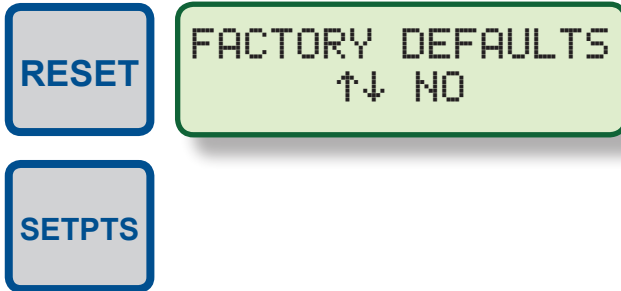

The user can, at any time during the life of the monitor, reinstate the factory default configuration. Press **SETUP** to display **AUTOSCAN**, then press **RESET**, then press **SETPTS**. The screen will read **FACTORY DEFAULTS NO**. Press the ▲ or ▼ arrow key to display **YES** and press **ENTER**. **SEE THE FLOWCHART ON PAGE 35**. All of the configuration parameters will be returned to the factory default values. Refer to the **MODBUS TABLES** for the factory default values.

11.4 FILTER



The display filter can be used to slow down the amount of change to the vibration reference numbers that can occur from a constantly changing sensor input signal. Changing the filter value has a direct affect on the output switch reaction time. The rate of change is less for larger values. The filter value is read-out in a number from **1** to **255**, **1** being no filter value and **255** being maximum filter value. Use the ▲ or ▼ arrow keys to increase or decrease the filter value and press **ENTER** to save.

11.5 DISPLAY RESOLUTION



DISPLAY RES. displays the amplitude reference number in units or tens (the far right digit is always zero).

11.6 # OF CHANNELS

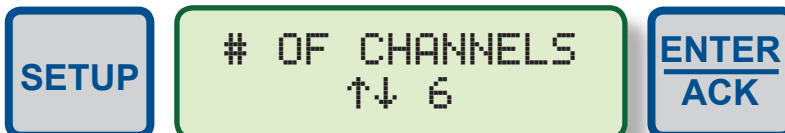

Use the **# OF CHANNELS** menu to configure the **VSM** for the maximum number of channels used. The channels not used have no affect on the timers and output switches. The maximum number of channels is **4** for the **VSM-400** and **8** for the **VSM-800**.

11.7 CHANNEL LABELS

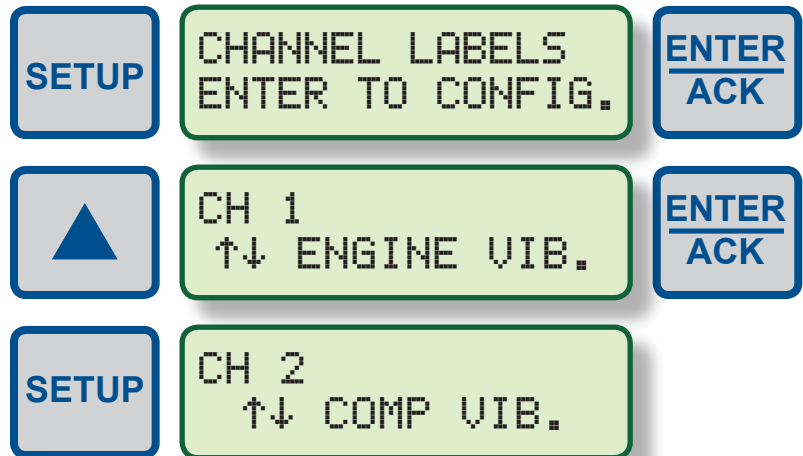

Each channel can have its own unique label to describe the monitored vibration point. There are several standard labels available as well as the ability to enter a custom label. To select a standard label use the **SETUP** key to select a channel. Use the up or down arrow keys to scroll through the available labels and press **ENTER** to save. If a custom label is required select ***CUSTOM*** and enter the **12** characters max through modbus. See modbus table in the back of the manual for proper registers, **6** per channel. Enter the characters in high byte – low byte format.

11.8 START DELAY TIMER

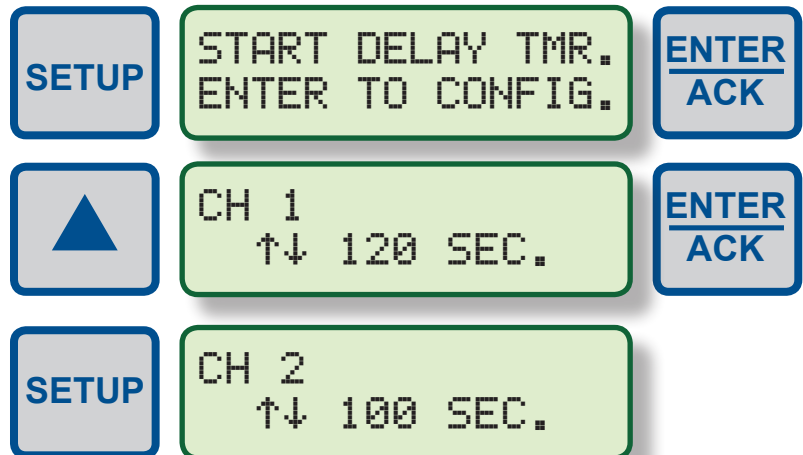

During engine or machine startup the vibration signals may reach levels above normal run vibration levels. The **START DELAY TIMER** is used to lock-out the output switches during engine or machine startup. The start delay timer for each channel begins counting down from its configured time when the startup lockout terminal on the back of the monitor is released from ground and is allowed to go high. Each channel can be individually set from **0 to 999** seconds.

11.9 SENSOR GAIN

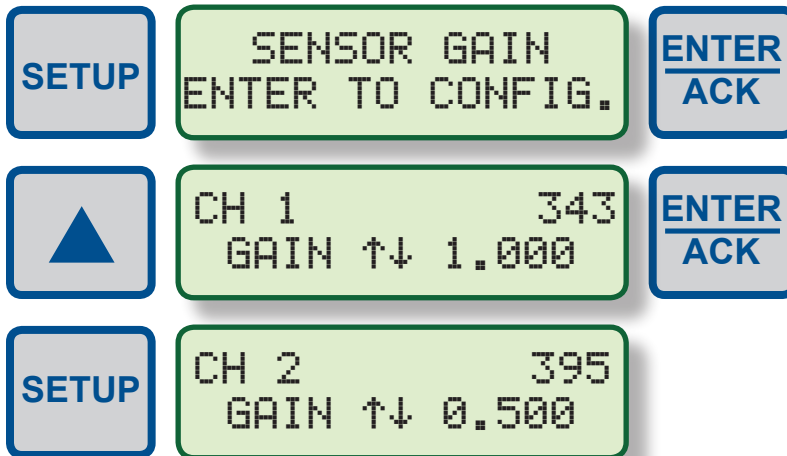

The **SENSOR GAIN** adjustment is used to increase or decrease the signal gain from the sensor. If the signal from the sensor results in the reading being too low or too high with the current gain value, the gain menu can be used to bring the reading into the desired range. Each channel can be individually set from **.111** (a small gain value) to **2.0** (a large gain value). If possible, it is suggested to use a similar gain value for all channels. By using a similar gain value for all channels, with respect to each other, a larger vibration will be displayed as a larger value and a smaller vibration will be displayed as a smaller value.

11.10 TRIP DELAY TIME

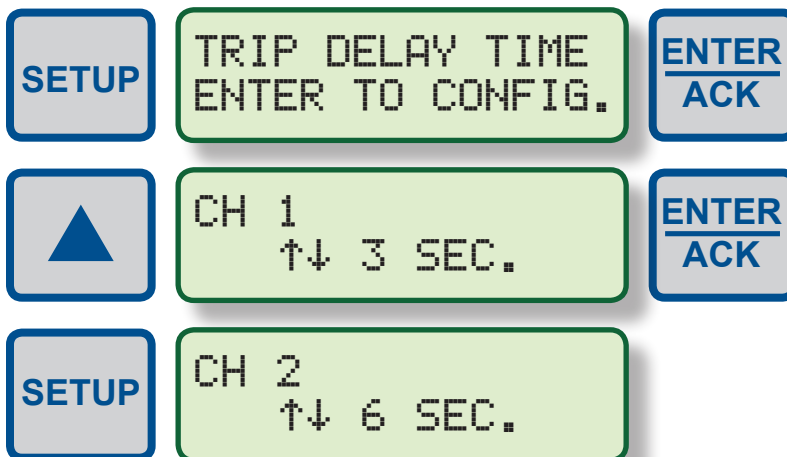

The **TRIP DELAY TIME** is used to delay tripping the output switches during a sudden momentary increase in a monitored vibration level. Should a sudden momentary increase in a vibration level occur caused by a one-time impact that is shorter in duration than the **Trip Delay Time** the monitor will show the impact but the output switches will not trip. Harmful vibrations are typically of the repeating type and will last longer than the **Trip Delay Time**. Each channel can be individually set from **0 to 15** seconds.



WARNING:

EXCESSIVE VIBRATION FOR AN EXTENDED TIME PERIOD CAN RESULT IN EQUIPMENT DAMAGE AND/OR PERSONAL INJURY. ADJUST THE TRIP DELAY TIME FOR THE SHORTEST REQUIRED DURATION.

11.11 OUTPUT SWITCHES

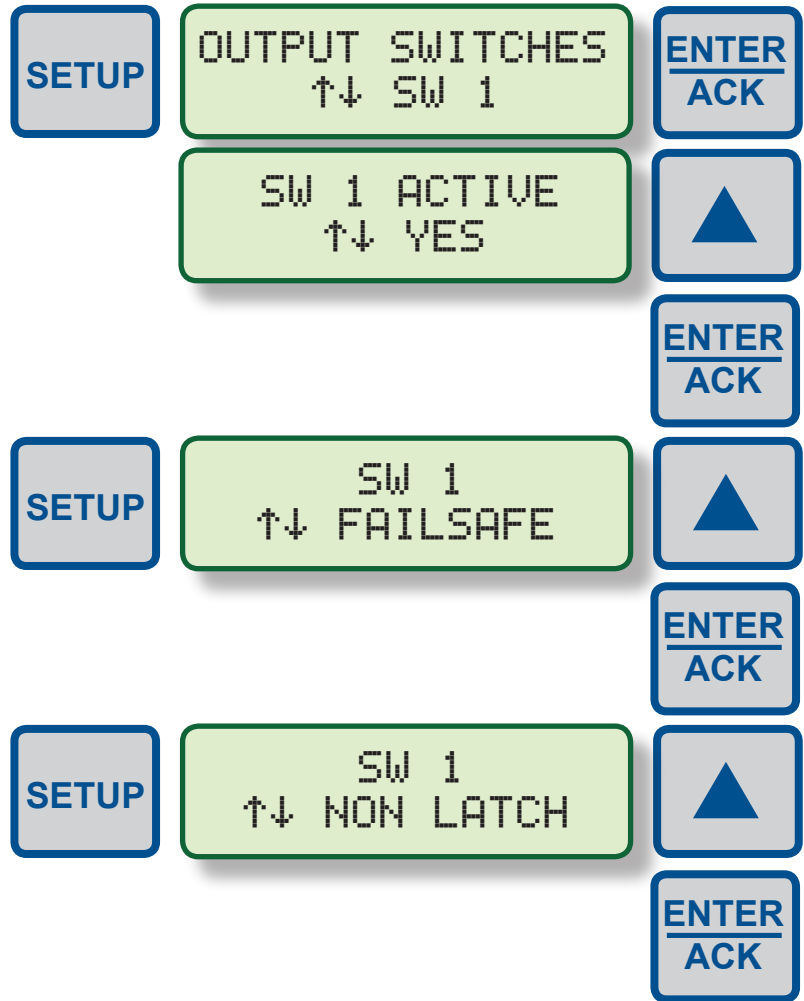

There are two output switches, typically switch **1** is for **ALARM** and switch **2** is for **SHUTDOWN**. Each switch can be set to be active or inactive, shelf or failsafe, and latching or non-latching. Shelf state is when the outputs are in the same condition with no faults as when unpowered; failsafe is when they are opposite. In non-latching mode, the output switch changes state when the setpoints come out of violation; in latching mode, a reset event is required to clear the switches from the tripped state. Unpowered states for the switches are closed for **SW 1** and open for **SW 2**.

11.12 OUTPUT SWITCH #1

Output switch #1 is designed to be used as an alarm. The switch is activated when an alarm setpoint value is violated for any monitored sensor.

11.12.1 ACTIVE

If **YES** is selected, output switch #1 will be active. If **NO** is selected, it will not activate.

11.12.2 SHELF OR FAILSAFE STATE

Switch #1 is a closed switch when in the shelf state (with the absence of power). The switch can be configured for either failsafe or shelf state. When set to **Shelf** state, the output switch will be closed when no setpoint values are violated. When set to **Failsafe**, the output switch will be open when no setpoint values are violated. If set to **Failsafe** and the power is lost to the **Monitor**, the output switch will change states (it will close).

11.12.3 NONLATCH OR LATCH

Switch #1 can be configured for latching or non-latching. When set to **Latch** the switch will stay tripped continuously until it is either reset manually (using the **RESET** key on the keypad), a reset is sent via **Modbus**, the power is cycled, or the reset terminal is grounded. When set to **Non latch** the switch will stay tripped if any channel's reference number is above the setpoint values. It will automatically reset when the values have returned to within the limits plus the hysteresis time set. Default is **5** seconds.

11.12.4 TRIP ON BAD SENSOR SETPOINT

A bad sensor, when diagnosed, will display **BAD SENSOR** alternating with the current condition on the LCD. Press the **VIEWALARMS** key to view and acknowledge the cause of the condition. The **ENTER/ACK** key when pressed will acknowledge the condition.

11.13 OUTPUT SWITCH #2

Output Switch #2 is designed to be used as a shutdown output. The switch is activated when a shutdown setpoint value has been violated. The switch can be connected to an **Altronic Annunciator System**, an ignition low voltage shutdown input, or to pilot-duty relays.

11.13.1 ACTIVE

If **YES** is selected, output switch #2 will be active. If **NO** is selected, it will not activate.

11.13.2 SHELF or FAILSAFE STATE

Switch #2 is an open switch when in the shelf state (with the absence of power). The switch can be configured for either **Failsafe** or **Shelf** state. When set to **Shelf** state, the output switch will be open for normal run conditions. When set to **Failsafe**, the output switch will be closed for normal run conditions. If set to **Failsafe** and the power is lost to the **Monitor**, the output switch will change states (it will open).

11.13.3 NON LATCH or LATCH

Switch #2 can be configured for latching or non-latching. When set to **Latch**, the switch will stay tripped continuously until it is either reset manually (using the **RESET** key on the keypad), a reset is sent via **Modbus**, the power is cycled, or the reset terminal is grounded. When set to non latch, the switch will stay tripped if any channel's reference number is above the setpoint value. It will automatically reset when the value has returned to within the limits plus the hysteresis time set. The default hysteresis time is **5** seconds.

11.14 BAD SENSOR SWITCH SELECTION

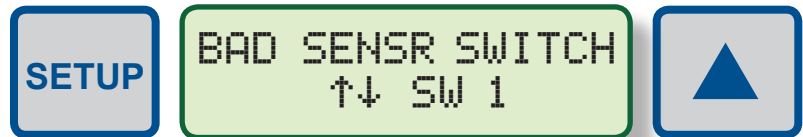

Use the **BAD SENSOR SWITCH** menu to select for either switch **1** or **2** to trip for a bad sensor detection. If set to **SW1**, switch **1** will trip when a bad sensor is detected; **SW2**, switch **2** will trip when a bad sensor is detected. To disable this feature, use the setpoints menu and select **OFF** for the bad sensor setpoint value of each channel. **SEE SECTION 10.2** for details.

11.15 COMMUNICATIONS



The **VSM Vibration Monitor** is part of a system designed to easily interface to popular computers, PLC's, and instruments. The serial communications are compliant to the **Modicon Modbus RTU** standard and uses **RS485** for its hardware communication format. To view or adjust the communication parameters, select **COMMUNICATIONS** from the menu and press **ENTER**. Select the node number from **01 to 99**. Select the baud rate. The following baud rates are available: **9600, 19200, 38400, 57600, and 115200**.

11.16 SECURITY

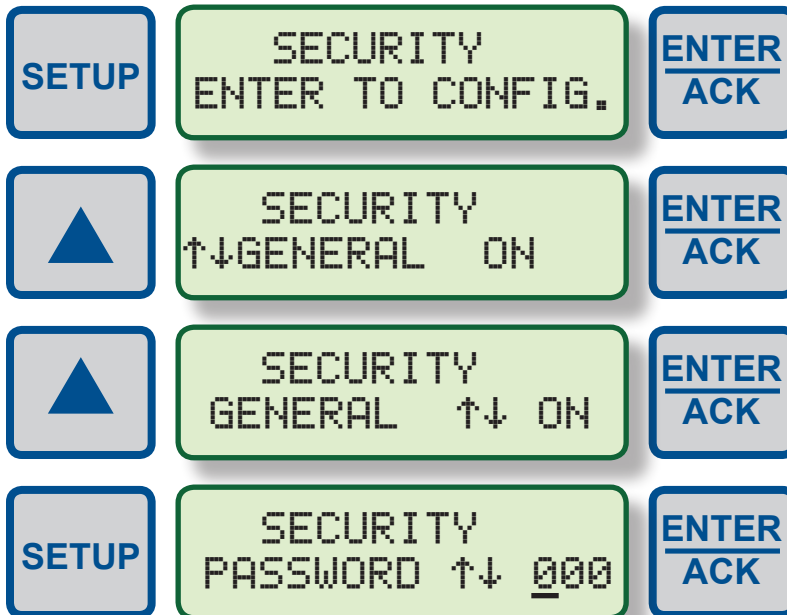

The security feature allows for protection from data inadvertently being changed. There are several areas in the menu system that can be protected as well as two layers of protection. The menus that can be protected are the **GENERAL SETTINGS**, the **SETPOINT VALUES**, and the ability to make **COMMUNICATIONS** setting changes. When protection is **ON**, the user is able to view the values in the menu but not able to change them. If an attempt is made to change the values the display will read **PASSWORD PROTECTED!**. The user must enter the proper password in the security menu to be able to make changes. If the correct password is entered, and protection is set to **OFF**, the requested values can be changed. To enter, set, or change a password, select **SECURITY** from the menu and press **ENTER**. Each of the areas (**GENERAL**, **SETPOINT**, and **COMMUNICATIONS**) can individually be turned on or off by using the **▲** or **▼** arrow keys and pressing **ENTER**. When an area is protected, the display will read **ON**, not protected will show as **OFF**. To enter a password, when in the security menu, press **SETUP**, **ENTER** **PASSWORD** will be displayed. Use the **▲** or **▼** arrow keys to increase or decrease each of the **3**-digit password numbers and press **ENTER**. Any number from **000** to **999** can be used.

NOTE: Autoscan, filter values, display resolution, and reset cannot be locked out by security protection.

11.16.1 GENERAL

When set to **ON**, prevents the user from changing # **OF CHANNELS**, **CHANNEL LABELS**, **START DELAY TIMER**, **SENSOR GAIN**, **TRIP DELAY TIME**, **OUTPUT SWITCHES**, AND **BAD SENSOR SWITCH**.

11.16.2 SETPOINT VALUES

When set to **ON**, prevents the user from changing the setpoint values. All setpoint values can be read but not changed.

11.16.3 COMMUNICATIONS

When set to **ON** prevents the user from changing the **Modbus** register data via the **Modbus** serial communications. The user can read data but not write data when communications protection is on. If the user attempts to perform a **Modbus** write, the error message **INVALID FUNCTION CODE** will be sent.

11.16.4 PASSWORD

A numerical password is the second level of protection. When **Set Security Password** is selected, the user will be prompted to enter a **3**-digit password. To enter a password, use the **▲** or **▼** arrow key to increase or decrease the underlined digit from **0 to 9** and press **ENTER**. The next digit will be underlined, use the same procedure to continue to enter a **3**-digit password and press **ENTER** to save. Any number from **000 to 999** can be used. When the password is set to **000**, no password will be required to make changes to the security screen.

With a password set, if an attempt is made to turn off any of the security bits in the security menu, the message **PASSWORD PROTECTED!** will appear. To allow changes, from the security menu press **SETUP** to access the password screen. If the proper password is entered, the user can turn off the security bits. Changes will now be allowed. If the incorrect password is entered, the display will show **PASSWORD INVALID** and continue to deny access to the protected menus.

12.0 VIEW ALARMS MENU

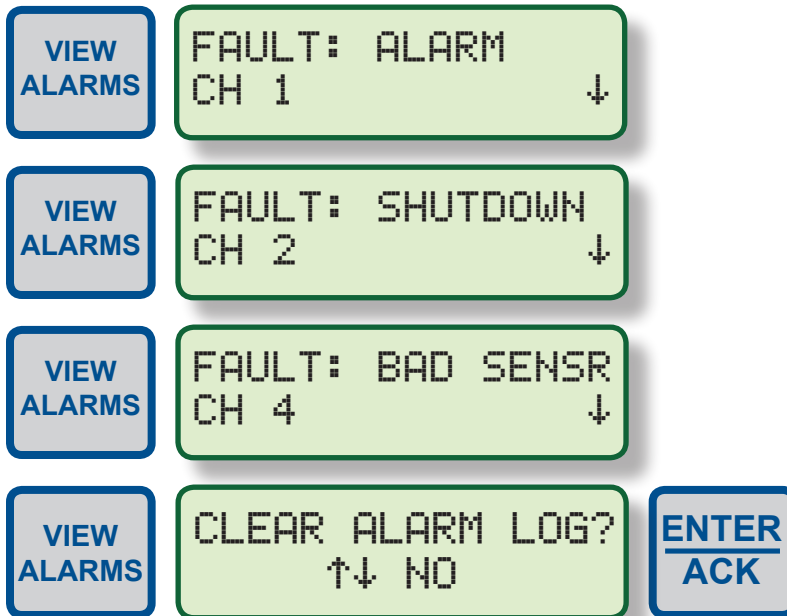

Selecting **VIEW ALARMS** displays the alarm, shutdown or bad sensor faults that occurred when a setpoint was violated. The screen shows the fault recorded as **ALARM**, **SHUTDOWN**, or **BAD SENSOR**, and the description of the channel that caused the fault. Pressing either the **VIEW ALARMS** or the down arrow key ▼ will show the preceding faults with the most current shown first. Each occurrence will appear once. After displaying all of the registered occurrences, the display will show **CLEAR ALARM LOG? NO**. Using the ▲ or ▼ arrow keys, choose **YES** to clear the log or **NO** to retain the log, and then press **ENTER**. The display will revert to the home screen. The logs are held in RAM only (volatile memory). If power is lost all past logs will be cleared. If no occurrences are logged, the display will show **NO ALARMS! ESC TO CONTINUE**, press **ESC** to return to the home screen. Each time a setpoint is violated a new status log will be saved; the oldest (past the log quantity limit) previous log messages will be overwritten. A maximum of **32** logs can be displayed.

13.0 RS485 COMMUNICATIONS, MODBUS RTU

The **VSM** is compliant to the **Modicon Modbus RTU** standard. Maximum number of registers that can be read at one time is limited to **32**. Maximum number of booleans that can be read at one time is limited to **256**. The default configuration is **19200 baud, 8 Data bits, No Parity, 1 Stop bit (19200 8N1)**. The **MODBUS** address list is on the following pages.

Location	Label	0	1	Default	Notes
Read/ Write bits					
00000's	Global Functions				
00001	Reserved				
00002	Enable Display By Tens mode	No	Yes	0	Displays vibration level values by tens
00003	Protect Configuration	Off	On	0	Protect general configuration from being changed
00004	Protect Setpoints	Off	On	0	Protect setpoint configuration from being changed
00005	Protect Comms	Off	On	0	Protect Communication configuration from being changed
00006	Switch 1 Enabled (1=on)	Off	On	1	switch 1 setup
00007	Switch 1 State (0=SHELF 1=FS)	shelf	failsafe	0	
00008	Switch 1 Type (1=Latched)	non-latch	latch	0	
00009	Bad Sensor Switch Select (0=SWITCH 1)	0	1	0	
00010	Switch 2 Enabled (1=on)	Off	On	1	switch 2 setup
00011	Switch 2 State (0=SHELF 1=FS)	shelf	failsafe	0	
00012	Switch 2 Type (1=Latched)	non-latch	latch	0	
00013	RESERVED				
00014	RESERVED				
00015	RESET (1 = RESET)			0	
00016	STARTUP LOCKOUT (1 = LOCKOUT)			0	
00017 THROUGH 00128	RESERVED				

VSM-400/VSM-800 VIBRATION MONITOR

Location	Label	0	1	Notes
Read only bits				
10000's	Global Functions			
10001	RESERVED			
10002	RESERVED			
10003	Switch 1 Activated	No	Yes	Output switch 1 activated by vibration
10004	Switch 2 Activated	No	Yes	Output switch 2 activated by vibration
10005 THROUGH 10008	RESERVED			
10009	Factory Calibrate R/W	Read only	Write	Factory Calibration Read/Write
10010	Watchdog	No	Yes	
10011	System Resetting	No	Yes	Reset condition is active
10012	RESERVED			
10013	Startup Locked Out Externally	outputs active	outputs inactive	Startup terminal is active
10014	Alarm/Shutdown Present	no alarms	alarms	Alarm/Shutdown is present
10015	RESERVED			
10016	RESERVED			
	Individual Functions			
10017	1 Sensor Status	OK	Bad Sensor	Sensor is detected and operating properly or is not detected
10018	2 Sensor Status	OK	Bad Sensor	Sensor is detected and operating properly or is not detected
10019	3 Sensor Status	OK	Bad Sensor	Sensor is detected and operating properly or is not detected
10020	4 Sensor Status	OK	Bad Sensor	Sensor is detected and operating properly or is not detected
10021	5 Sensor Status	OK	Bad Sensor	Sensor is detected and operating properly or is not detected
10022	6 Sensor Status	OK	Bad Sensor	Sensor is detected and operating properly or is not detected
10023	7 Sensor Status	OK	Bad Sensor	Sensor is detected and operating properly or is not detected
10024	8 Sensor Status	OK	Bad Sensor	Sensor is detected and operating properly or is not detected
10025 THROUGH 10032	RESERVED			
10033	1 SW 2 (SHUTDOWN) SETPOINT	OK	vibration detected	SHUTDOWN SETPOINT Exceeded on Input 1
10034	2 SW 2 (SHUTDOWN) SETPOINT	OK	vibration detected	SHUTDOWN SETPOINT Exceeded on Input 2
10035	3 SW 2 (SHUTDOWN) SETPOINT	OK	vibration detected	SHUTDOWN SETPOINT Exceeded on Input 3

Location	Input #	Individual Functions	0	1	Notes
10036	4	SW 2 (SHUTDOWN) SETPOINT	OK	vibration detected	SHUTDOWN SETPOINT Exceeded on Input 4
10037	5	SW 2 (SHUTDOWN) SETPOINT	OK	vibration detected	SHUTDOWN SETPOINT Exceeded on Input 5
10038	6	SW 2 (SHUTDOWN) SETPOINT	OK	vibration detected	SHUTDOWN SETPOINT Exceeded on Input 6
10039	7	SW 2 (SHUTDOWN) SETPOINT	OK	vibration detected	SHUTDOWN SETPOINT Exceeded on Input 7
10040	8	SW 2 (SHUTDOWN) SETPOINT	OK	vibration detected	SHUTDOWN SETPOINT Exceeded on Input 8
10041 THROUGH 10048	RESERVED				
10049	1	SW1 (ALARM) SETPOINT	OK	vibration detected	ALARM SETPOINT Exceeded on Input 1
10050	2	SW1 (ALARM) SETPOINT	OK	vibration detected	ALARM SETPOINT Exceeded on Input 2
10051	3	SW1 (ALARM) SETPOINT	OK	vibration detected	ALARM SETPOINT Exceeded on Input 3
10052	4	SW1 (ALARM) SETPOINT	OK	vibration detected	ALARM SETPOINT Exceeded on Input 4
10053	5	SW1 (ALARM) SETPOINT	OK	vibration detected	ALARM SETPOINT Exceeded on Input 5
10054	6	SW1 (ALARM) SETPOINT	OK	vibration detected	ALARM SETPOINT Exceeded on Input 6
10055	7	SW1 (ALARM) SETPOINT	OK	vibration detected	ALARM SETPOINT Exceeded on Input 7
10056	8	SW1 (ALARM) SETPOINT	OK	vibration detected	ALARM SETPOINT Exceeded on Input 8
10057 THROUGH 10064	RESERVED				
10065	1	Channel 1 Armed Status	Not Armed	Armed	
10066	2	Channel 2 Armed Status	Not Armed	Armed	
10067	3	Channel 3 Armed Status	Not Armed	Armed	
10068	4	Channel 4 Armed Status	Not Armed	Armed	
10069	5	Channel 5 Armed Status	Not Armed	Armed	
10070	6	Channel 6 Armed Status	Not Armed	Armed	
10071	7	Channel 7 Armed Status	Not Armed	Armed	
10072	8	Channel 8 Armed Status	Not Armed	Armed	
10073 THROUGH 10128	RESERVED				

VSM-400/VSM-800 VIBRATION MONITOR

Location	Label	Size(bits)	Notes	
Read only bytes				
30000's	Global Functions			
30001	InStat 001-016		MISC.	
30002	InStat 017-032		BAD SENSOR Status	
30003	InStat 033-048		SHUTDOWN SETPOINT Status	
30004	InStat 049-064		ALARM SETPOINT Status	
30005	InStat 065-080		ARMED Status	
30006	InStat 081-096			
30007	InStat 097-112			
30008	InStat 113-128			
30009	RESERVED			
30010	Supply Voltage (1234 = 12.34V)	16	Voltage measured at supply terminals	
30011	RESERVED			
30012	RESERVED			
30013	RESERVED			
30014	FACTORY			
	Input #	Individual Functions	Min	Max
30015	Ch 1	Vibration Level	0	1023
30016	Ch 2	Vibration Level	0	1023
30017	Ch 3	Vibration Level	0	1023
30018	Ch 4	Vibration Level	0	1023
30019	Ch 5	Vibration Level	0	1023
30020	Ch 6	Vibration Level	0	1023
30021	Ch 7	Vibration Level	0	1023
30022	Ch 8	Vibration Level	0	1023
30023 THROUGH 30029	RESERVED			

Location	Label
30030	Event Log 00 (MOST CURRENT/NEWEST)
30031	Event Log 01
30032	Event Log 02
30033	Event Log 03
30034	Event Log 04
30035	Event Log 05
30036	Event Log 06
30037	Event Log 07
30038	Event Log 08
30039	Event Log 09
30040	Event Log 10
30041	Event Log 11
30042	Event Log 12
30043	Event Log 13
30044	Event Log 14
30045	Event Log 15
30046	Event Log 16
30047	Event Log 17
30048	Event Log 18
30049	Event Log 19
30050	Event Log 20
30051	Event Log 21
30052	Event Log 22
30053	Event Log 23
30054	Event Log 24
30055	Event Log 25
30056	Event Log 26
30057	Event Log 27
30058	Event Log 28
30059	Event Log 29
30060	Event Log 30
30061	Event Log 31 (Maximum) (LEAST CURRENT/OLDEST)
30062 THROUGH 30128	RESERVED

EVENT LOG FORMAT

A → 1 = ALARM
2 = SHUTDOWN
3 = BAD SENSOR

B → CHANNEL # 1 – 8

C → CAPTURED VALUE AT TRIP POINT

VSM-400/VSM-800 VIBRATION MONITOR

Location	Label	Min	Max	Default	Notes
Read/Write bytes					
40000's	Global Functions				
40001	Coils 001-016	00000	65535		MISC.
40002	Coils 017-032	00000	65535		
40003	Coils 033-048	00000	65535		
40004	Coils 049-064	00000	65535		
40005	Coils 065-080	00000	65535		
40006	Coils 081-096	00000	65535		
40007	Coils 097-112	00000	65535		
40008	Coils 113-128	00000	65535		
40009	AutoScan (1-30 sec.)	0	30	0	0 = OFF, 1 - 30 SEC.
40010	Node Number (1-99)	1	99	1	
40011	Baud Rate 0=9.6k,1=19.2K ...	0	4	1	0 = 9.6K, 1 = 19.2K, 2 = 38.4K, 3 = 57.6K, 4 = 115.2K
40012	Security Password (000-999)	0	999	000	
40013	Lag Filter Gain Value (1-255)	1	255	240	
40014	Number of Channels (1-8)	1	8	8	DEFAULT = 4 FOR VSM-400, 8 FOR VSM-800
40015	FACTORY	1	65535	10	
40016	Switch Hysteresis Time (0-15)	0	15	5	
40017	FACTORY	00000	65535	20000	
40018	Offset Ch's 1-4	0	+500	0	Factory Calibration
40019	Offset Ch's 5-8	0	+500	0	Factory Calibration
40020	Dynamic Filter Step Size	0	1024	50	Factory Set
40021	Dynamic Filter Gain Delay	0	255	15	Factory Set
40022 THROUGH 40039	RESERVED	00000	65535	00000	
40040	Ch#1 Prescale (0-8)	0	8	0	
40041	Ch#1 Gain (0-63)	0	63	14	SEE GAIN CHART, PAGE 32
40042	Ch#1 BP filter freq(0-63)	0	63	63	
40043	Ch#1 time const (0-31)	0	31	31	
40044	Ch#1 (ALARM) Setpoint (0-999)	0	999	700	
40045	Ch#1 (SD) Setpoint (0-999)	0	999	800	
40046	Ch#1 Bad Sens. Setpoint(0-999)	0	999	0	
40047	Ch#1 Output Offset	0	500	0	
40048	Ch#1 Output Scalar(1234=12.34)	0	9999	100	
40049	Ch#1 Label Type (0-48)	0	48	0	
40050	Ch#1 Custom Label chars 1 2	00000	65535	22616	ASCII CHAR 1 LOW, CHAR 2 HIGH, IN DECIMAL
40051	Ch#1 Custom Label chars 3 4	00000	65535	22616	
40052	Ch#1 Custom Label chars 5 6	00000	65535	22616	
40053	Ch#1 Custom Label chars 7 8	00000	65535	22616	
40054	Ch#1 Custom Label chars 9 10	00000	65535	22616	
40055	Ch#1 Custom Label chars 11 12	00000	65535	22616	
40056	Ch#1 Start Delay Timer (0-999)	0	999	60	SECONDS

Location	Label	Min	Max	Default	Notes
40057	Ch#1 Trip Delay Timer (0-15)	0	15	3	SECONDS
40058	Ch#1 RESERVED	00000	65535	00000	
40059	Ch#1 RESERVED	00000	65535	00000	
40060	Ch#2 Prescale (0-8)	0	8	0	
40061	Ch#2 Gain (0-63)	0	63	14	SEE GAIN CHART, PAGE 32
40062	Ch#2 BP filter freq(0-63)	0	63	63	
40063	Ch#2 time const (0-31)	0	31	31	
40064	Ch#2 (ALARM) Setpoint (0-999)	0	999	700	
40065	Ch#2 (SD) Setpoint (0-999)	0	999	800	
40066	Ch#2 Bad Sens. Setpoint(0-999)	0	999	0	
40067	Ch#2 Output Offset	0	500	0	
40068	Ch#2 Output Scalar(1234=12.34)	0	9999	100	
40069	Ch#2 Label Type (0-48)	0	48	0	
40070	Ch#2 Custom Label chars 1 2	00000	65535	22616	ASCII CHAR 1 LOW, CHAR 2 HIGH, IN DECIMAL
40071	Ch#2 Custom Label chars 3 4	00000	65535	22616	
40072	Ch#2 Custom Label chars 5 6	00000	65535	22616	
40073	Ch#2 Custom Label chars 7 8	00000	65535	22616	
40074	Ch#2 Custom Label chars 9 10	00000	65535	22616	
40075	Ch#2 Custom Label chars 11 12	00000	65535	22616	
40076	Ch#2 Start Delay Timer (0-999)	0	999	60	
40077	Ch#2 Trip Delay Timer (0-15)	0	15	3	
40078	Ch#2 RESERVED	00000	65535	00000	
40079	Ch#2 RESERVED	00000	65535	00000	
40080	Ch#3 Prescale (0-8)	0	8	0	
40081	Ch#3 Gain (0-63)	0	63	14	SEE GAIN CHART, PAGE 32
40082	Ch#3 BP filter freq(0-63)	0	63	63	
40083	Ch#3 time const (0-31)	0	31	31	
40084	Ch#3 (ALARM) Setpoint (0-999)	0	999	700	
40085	Ch#3 (SD) Setpoint (0-999)	0	999	800	
40086	Ch#3 Bad Sens. Setpoint(0-999)	0	999	0	
40087	Ch#3 Output Offset	0	500	0	
40088	Ch#3 Output Scalar(1234=12.34)	0	9999	100	
40089	Ch#3 Label Type (0-48)	0	48	0	
40090	Ch#3 Custom Label chars 1 2	00000	65535	22616	ASCII CHAR 1 LOW, CHAR 2 HIGH, IN DECIMAL
40091	Ch#3 Custom Label chars 3 4	00000	65535	22616	
40092	Ch#3 Custom Label chars 5 6	00000	65535	22616	
40093	Ch#3 Custom Label chars 7 8	00000	65535	22616	
40094	Ch#3 Custom Label chars 9 10	00000	65535	22616	
40095	Ch#3 Custom Label chars 11 12	00000	65535	22616	
40096	Ch#3 Start Delay Timer (0-999)	0	999	60	
40097	Ch#3 Trip Delay Timer (0-15)	0	15	3	
40098	Ch#3 RESERVED	00000	65535	00000	
40099	Ch#3 RESERVED	00000	65535	00000	

VSM-400/VSM-800 VIBRATION MONITOR

Location	Label	Min	Max	Default	Notes
40100	Ch#4 Prescale (0-8)	0	8	0	
40101	Ch#4 Gain (0-63)	0	63	14	SEE GAIN CHART, PAGE 32
40102	Ch#4 BP filter freq(0-63)	0	63	63	
40103	Ch#4 time const (0-31)	0	31	31	
40104	Ch#4 (ALARM) Setpoint (0-999)	0	999	700	
40105	Ch#4 (SD) Setpoint (0-999)	0	999	800	
40106	Ch#4 Bad Sens. Setpoint(0-999)	0	999	0	
40107	Ch#4 Output Offset	0	500	0	
40108	Ch#4 Output Scalar(1234=12.34)	0	9999	100	
40109	Ch#4 Label Type (0-48)	0	48	0	
40110	Ch#4 Custom Label chars 1 2	00000	65535	22616	ASCII CHAR 1 LOW, CHAR 2 HIGH, IN DECIMAL
40111	Ch#4 Custom Label chars 3 4	00000	65535	22616	
40112	Ch#4 Custom Label chars 5 6	00000	65535	22616	
40113	Ch#4 Custom Label chars 7 8	00000	65535	22616	
40114	Ch#4 Custom Label chars 9 10	00000	65535	22616	
40115	Ch#4 Custom Label chars 11 12	00000	65535	22616	
40116	Ch#4 Start Delay Timer (0-999)	0	999	60	
40117	Ch#4 Trip Delay Timer (0-15)	0	15	3	
40118	Ch#4 RESERVED	00000	65535	00000	
40119	Ch#4 RESERVED	00000	65535	00000	
40120	Ch#5 Prescale (0-8)	0	8	0	
40121	Ch#5 Gain (0-63)	0	63	14	SEE GAIN CHART, PAGE 32
40122	Ch#5 BP filter freq(0-63)	0	63	63	
40123	Ch#5 time const (0-31)	0	31	31	
40124	Ch#5 (ALARM) Setpoint (0-999)	0	999	700	
40125	Ch#5 (SD) Setpoint (0-999)	0	999	800	
40126	Ch#5 Bad Sens. Setpoint(0-999)	0	999	0	
40127	Ch#5 Output Offset	0	500	0	
40128	Ch#5 Output Scalar(1234=12.34)	0	9999	100	
40129	Ch#5 Label Type (0-48)	0	48	0	
40130	Ch#5 Custom Label chars 1 2	00000	65535	22616	ASCII CHAR 1 LOW, CHAR 2 HIGH, IN DECIMAL
40131	Ch#5 Custom Label chars 3 4	00000	65535	22616	
40132	Ch#5 Custom Label chars 5 6	00000	65535	22616	
40133	Ch#5 Custom Label chars 7 8	00000	65535	22616	
40134	Ch#5 Custom Label chars 9 10	00000	65535	22616	
40135	Ch#5 Custom Label chars 11 12	00000	65535	22616	
40136	Ch#5 Start Delay Timer (0-999)	0	999	60	
40137	Ch#5 Trip Delay Timer (0-15)	0	15	3	
40138	Ch#5 RESERVED	00000	65535	00000	
40139	Ch#5 RESERVED	00000	65535	00000	
40140	Ch#6 Prescale (0-8)	0	8	0	
40141	Ch#6 Gain (0-63)	0	63	14	SEE GAIN CHART, PAGE 32
40142	Ch#6 BP filter freq(0-63)	0	63	63	

Location	Label	Min	Max	Default	Notes
40143	Ch#6 time const (0-31)	0	31	31	
40144	Ch#6 (ALARM) Setpoint (0-999)	0	999	700	
40145	Ch#6 (SD) Setpoint (0-999)	0	999	800	
40146	Ch#6 Bad Sens. Setpoint(0-999)	0	999	0	
40147	Ch#6 Output Offset	0	500	0	
40148	Ch#6 Output Scalar(1234=12.34)	0	9999	100	
40149	Ch#6 Label Type (0-48)	0	48	0	
40150	Ch#6 Custom Label chars 1 2	00000	65535	22616	ASCII CHAR 1 LOW, CHAR 2 HIGH, IN DECIMAL
40151	Ch#6 Custom Label chars 3 4	00000	65535	22616	
40152	Ch#6 Custom Label chars 5 6	00000	65535	22616	
40153	Ch#6 Custom Label chars 7 8	00000	65535	22616	
40154	Ch#6 Custom Label chars 9 10	00000	65535	22616	
40155	Ch#6 Custom Label chars 11 12	00000	65535	22616	
40156	Ch#6 Start Delay Timer (0-999)	0	999	60	
40157	Ch#6 Trip Delay Timer (0-15)	0	15	3	
40158	Ch#6 RESERVED	00000	65535	00000	
40159	Ch#6 RESERVED	00000	65535	00000	
40160	Ch#7 Prescale (0-8)	0	8	0	
40161	Ch#7 Gain (0-63)	0	63	14	SEE GAIN CHART, PAGE 32
40162	Ch#7 BP filter freq(0-63)	0	63	63	
40163	Ch#7 time const (0-31)	0	31	31	
40164	Ch#7 (ALARM) Setpoint (0-999)	0	999	700	
40165	Ch#7 (SD) Setpoint (0-999)	0	999	800	
40166	Ch#7 Bad Sens. Setpoint(0-999)	0	999	0	
40167	Ch#7 Output Offset	0	500	0	
40168	Ch#7 Output Scalar(1234=12.34)	0	9999	100	
40169	Ch#7 Label Type (0-48)	0	48	0	
40170	Ch#7 Custom Label chars 1 2	00000	65535	22616	ASCII CHAR 1 LOW, CHAR 2 HIGH, IN DECIMAL
40171	Ch#7 Custom Label chars 3 4	00000	65535	22616	
40172	Ch#7 Custom Label chars 5 6	00000	65535	22616	
40173	Ch#7 Custom Label chars 7 8	00000	65535	22616	
40174	Ch#7 Custom Label chars 9 10	00000	65535	22616	
40175	Ch#7 Custom Label chars 11 12	00000	65535	22616	
40176	Ch#7 Start Delay Timer (0-999)	0	999	60	
40177	Ch#7 Trip Delay Timer (0-15)	0	15	3	
40178	Ch#7 RESERVED	00000	65535	00000	
40179	Ch#7 RESERVED	00000	65535	00000	
40180	Ch#8 Prescale (0-8)	0	8	0	
40181	Ch#8 Gain (0-63)	0	63	14	SEE GAIN CHART, PAGE 32
40182	Ch#8 BP filter freq(0-63)	0	63	63	
40183	Ch#8 time const (0-31)	0	31	31	
40184	Ch#8 (ALARM) Setpoint (0-999)	0	999	700	
40185	Ch#8 (SD) Setpoint (0-999)	0	999	800	

VSM-400/VSM-800 VIBRATION MONITOR

Location	Label	Min	Max	Default	Notes
40186	Ch#8 Bad Sens. Setpoint(0-999)	0	999	0	
40187	Ch#8 Output Offset	0	500	0	
40188	Ch#8 Output Scalar(1234=12.34)	0	9999	100	
40189	Ch#8 Label Type (0-48)	0	48	0	
40190	Ch#8 Custom Label chars 1 2	00000	65535	22616	ASCII CHAR 1 LOW, CHAR 2 HIGH, IN DECIMAL
40191	Ch#8 Custom Label chars 3 4	00000	65535	22616	
40192	Ch#8 Custom Label chars 5 6	00000	65535	22616	
40193	Ch#8 Custom Label chars 7 8	00000	65535	22616	
40194	Ch#8 Custom Label chars 9 10	00000	65535	22616	
40195	Ch#8 Custom Label chars 11 12	00000	65535	22616	
40196	Ch#8 Start Delay Timer (0-999)	0	999	60	
40197	Ch#8 Trip Delay Timer (0-15)	0	15	3	
40198	Ch#8 RESERVED	00000	65535	00000	
40199	Ch#8 RESERVED	00000	65535	00000	
40200 THROUGH 40256	RESERVED	00000	65535	00000	

GAIN CHART

Register Value	Gain	Register Value	Gain	Register Value	Gain
0	2.000	23	0.654	46	0.236
1	1.882	24	0.630	47	0.222
2	1.778	25	0.607	48	0.211
3	1.684	26	0.586	49	0.200
4	1.600	27	0.567	50	0.190
5	1.523	28	0.548	51	0.182
6	1.455	29	0.500	52	0.174
7	1.391	30	0.471	53	0.167
8	1.333	31	0.444	54	0.160
9	1.280	32	0.421	55	0.154
10	1.231	33	0.400	56	0.148
11	1.185	34	0.381	57	0.143
12	1.143	35	0.364	58	0.138
13	1.063	36	0.348	59	0.133
14	1.000	37	0.333	60	0.129
15	0.944	38	0.320	61	0.125
16	0.895	39	0.308	62	0.118
17	0.850	40	0.296	63	0.111
18	0.810	41	0.286		
19	0.773	42	0.276		
20	0.739	43	0.267		
21	0.708	44	0.258		
22	0.680	45	0.250		

FIGURES SECTION:

- 1. MOUNTING DIMENSIONS AND SPECIFICATIONS**
- 2. FLOWCHART**
- 3. MOUNTING, DIMENSIONS, AND SPECS – VIBRATION SENSORS**
- 4A. TYPICAL SENSOR MOUNTING LOCATIONS**
- 4B. TYPICAL SENSOR MOUNTING LOCATIONS**
- 5. WIRING DIAGRAM – POWER, INPUTS, AND OUTPUTS**
- 6. WIRING DIAGRAM – ALTRONIC ANNUNCIATOR SYSTEMS**
- 7. WIRING DIAGRAM – DC RELAYS**
- 8. WIRING DIAGRAM – RS485 COMMUNICATIONS, PC HOOK-UP**

VSM-400/VSM-800 VIBRATION MONITOR

FIGURE 1. MOUNTING DIMENSIONS AND SPECIFICATIONS

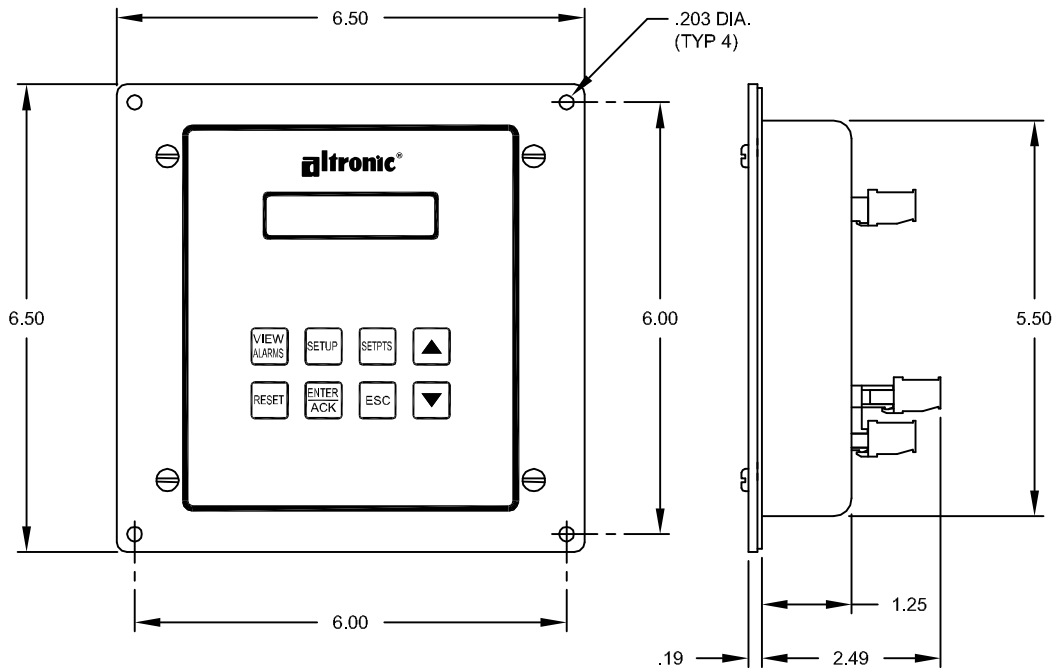

SPECIFICATIONS:

POWER REQUIRED: DC POWER 10-32 VDC, 0.20 AMP. MAX.

AMBIENT TEMPERATURE RANGE: -40°C TO 80°C (-40°F TO 176°F).

SENSORS: UP TO 8.

SENSOR TYPE: PIEZOELECTRIC VIBRATION SENSOR; BOSCH 0 261 231 148, ALTRONIC 615107, OR EQUIVALENT.

INPUT FREQUENCY RANGE: 4 HZ TO 1KHZ.

KEYPAD: 8-KEY MEMBRANE.

DISPLAY: BACKLIT, 2 X 16 CHARACTER, LCD.

DISPLAY UPDATE RATE: 0.5 SECONDS NOMINAL.

SENSOR SCAN RATE: 0.5 SECONDS.

OUTPUT SWITCH LOCKOUT TERMINAL: ACTIVATED BY PULLING TERMINAL LOW.

STARTUP OUTPUT LOCKOUT TIMER: 0 TO 999 SECONDS, ONE PER CHANNEL.

REMOTE RESET INPUT: ACTIVATED BY MOMENTARILY PULLING INPUT LOW.

OUTPUT SWITCH TRIP DELAY TIMER: 0 TO 15 SECONDS, ONE PER CHANNEL

OUTPUT SWITCH: TWO PROGRAMMABLE SOLID STATE SWITCHES, RATED 32 VDC, 0.2 AMP CONTINUOUS, OPTICALLY ISOLATED FROM POWER SUPPLY. ONE FOR ALARM, ONE FOR SHUTDOWN.

SWITCH RESPONSE TIME: TIED TO FILTER VALUE AND DISPLAY READING (WITH FILTER AT 1, MAX RESPONSE TIME IS APPROXIMATELY 0.5 SECONDS).

RS485 SERIAL OUTPUT: 1 MODBUS RTU

HAZARDOUS AREA CLASSIFICATION: CLASS I, DIV. 2, GROUPS C & D FOR DIRECT HOOKUP, TEMP CODE T4, MAX. AMBIENT TEMP. 80°C.

VSM-400/VSM-800 VIBRATION MONITOR

FIGURE 3. MOUNTING, DIMENSIONS, AND SPECS – VIBRATION SENSORS

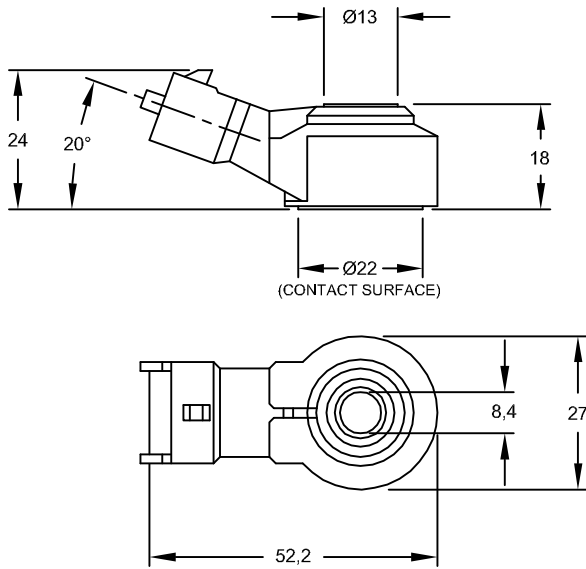

NOTE: DIMENSIONS ARE IN MILLIMETERS.

SPECIFICATIONS:

FREQUENCY RANGE: 1Hz - 20kHz

MEASURING RANGE: 0.1 - 400 g

SENSITIVITY AT 5 kHz: 26 ± 8 mV/g

OPERATING TEMPERATURE RANGE: -40°C - $+150^{\circ}\text{C}$

INSTALLATION:

MOUNTING BOLT: GREY CAST IRON: M8 X 25; GRADE 8.8
ALUMINUM: M8 X 30; GRADE 8.8

TIGHTENING TORQUE (OILED PERMITTED): 20 ± 5 N/m; 15 ± 1 Ft/Lb

MOUNTING POSITION: ARBITRARY

SENSITIVITY: PARALLEL WITH MOUNTING BOLT

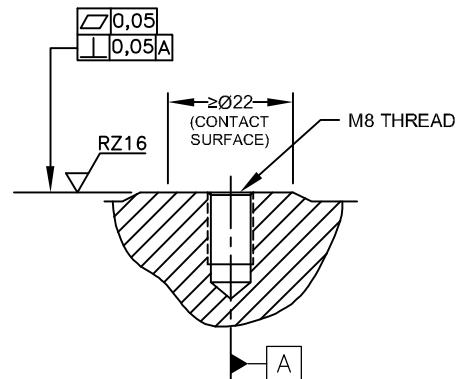

MOUNTING HOLE

INSTALLATION INSTRUCTIONS:

MOUNT THE VIBRATION SENSORS TO A SMOOTH SURFACE (COUNTERBORE IF NECESSARY) ON THE MACHINE TO BE MONITORED. A SURFACE THAT IS NOT SMOOTH WILL GIVE ERRATIC READINGS. ANGULAR MOUNTING POSITION IS ARBITRARY. DRILL AND TAP THE PART PERPENDICULAR TO THE SURFACE, TAKING CARE NOT TO PENETRATE THE WATERJACKET.

FIGURE 4A. TYPICAL SENSOR MOUNTING LOCATIONS

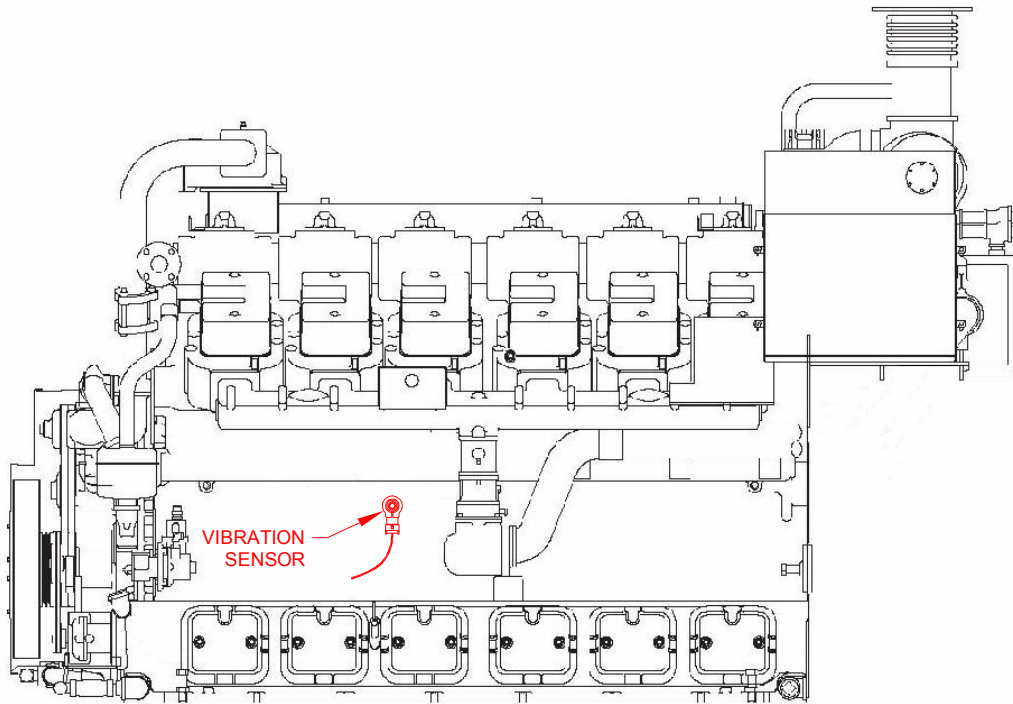

NOTES:

1. THE VIBRATION SENSOR IS MOST SENSITIVE PARALLEL TO THE MOUNTING BOLT.
2. MOUNT VIBRATION SENSOR ON BOTH SIDES OF ENGINE BLOCK.

ENGINE

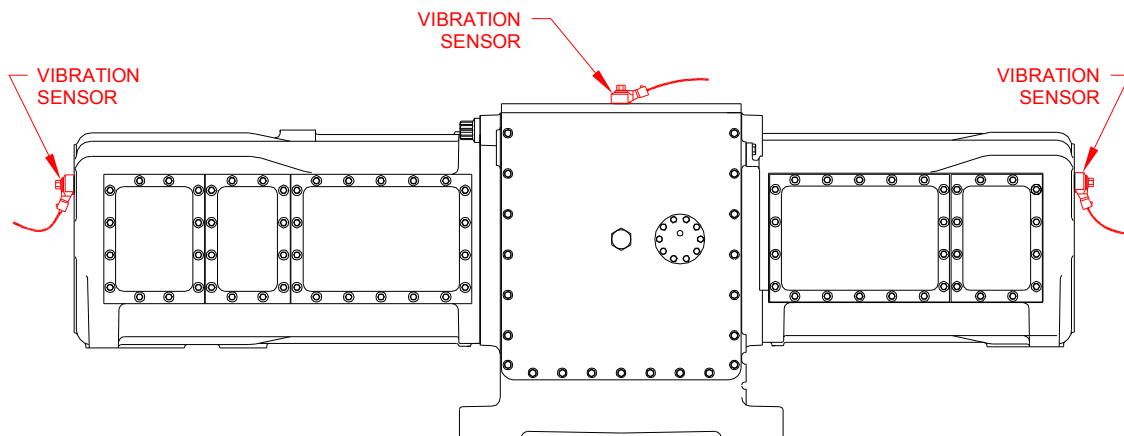

NOTES:

1. MOUNT VIBRATION SENSOR ON COMPRESSOR FRAME AND AT EACH HEAD.

COMPRESSOR

VSM-400/VSM-800 VIBRATION MONITOR

FIGURE 4B. TYPICAL SENSOR MOUNTING LOCATIONS

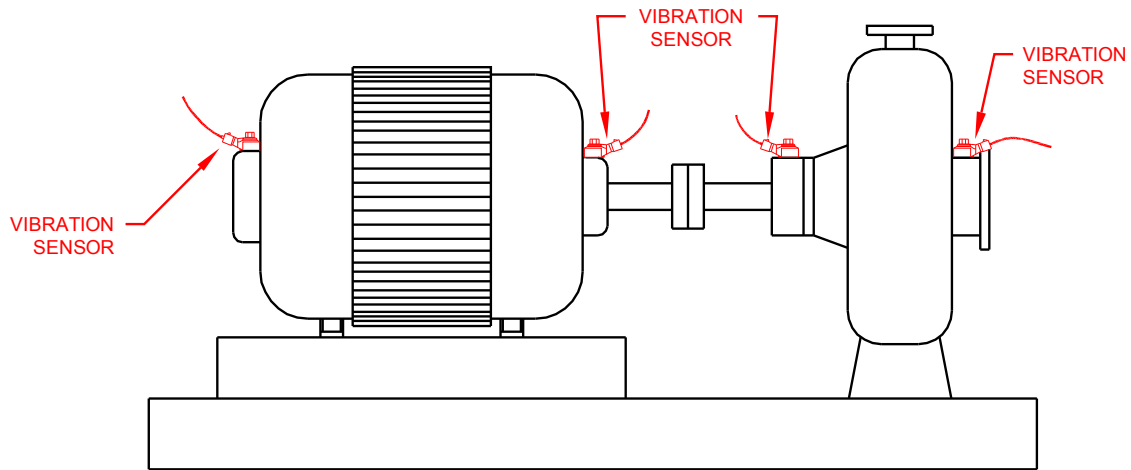

NOTES:

1. THE VIBRATION SENSOR IS MOST SENSITIVE PARALLEL TO THE MOUNTING BOLT.
2. MOUNT VIBRATION SENSOR PERPENDICULAR TO THE AXIS OF ROTATION.
3. MOST EFFECTIVE POSITION IS ON THE BEARING HOUSING; CLOSE TO THE CENTERLINE OF ROTATION.

MOTOR / PUMP

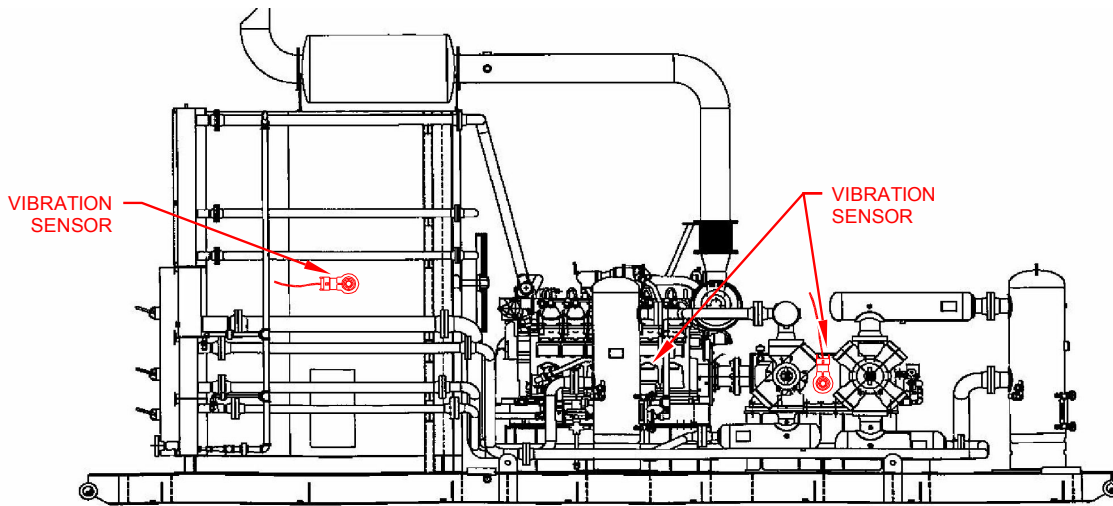

NOTES:

1. MOUNT VIBRATION SENSOR ON A RIGID LOCATION ON THE COOLER FRAME CLOSE TO CENTERLINE OF FAN SHAFT.
2. MOUNT VIBRATION SENSORS ON ENGINE BLOCK AND COMPRESSOR FRAME.

COOLER / ENGINE / COMPRESSOR

FIGURE 5. WIRING DIAGRAM – POWER, INPUTS, AND OUTPUTS

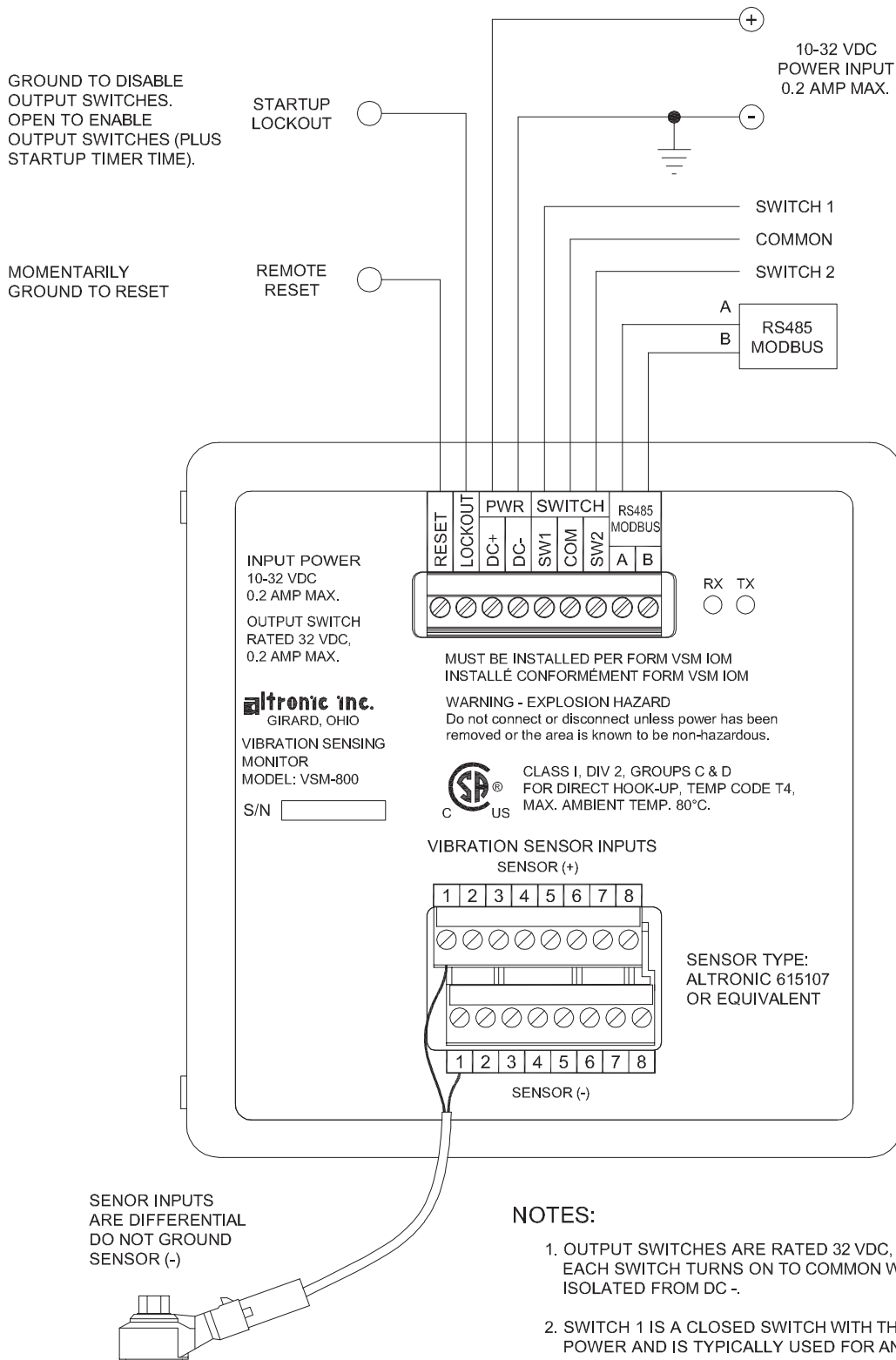

VSM-400/VSM-800 VIBRATION MONITOR

FIGURE 6. WIRING DIAGRAM – ALTRONIC ANNUNCIATOR SYSTEMS

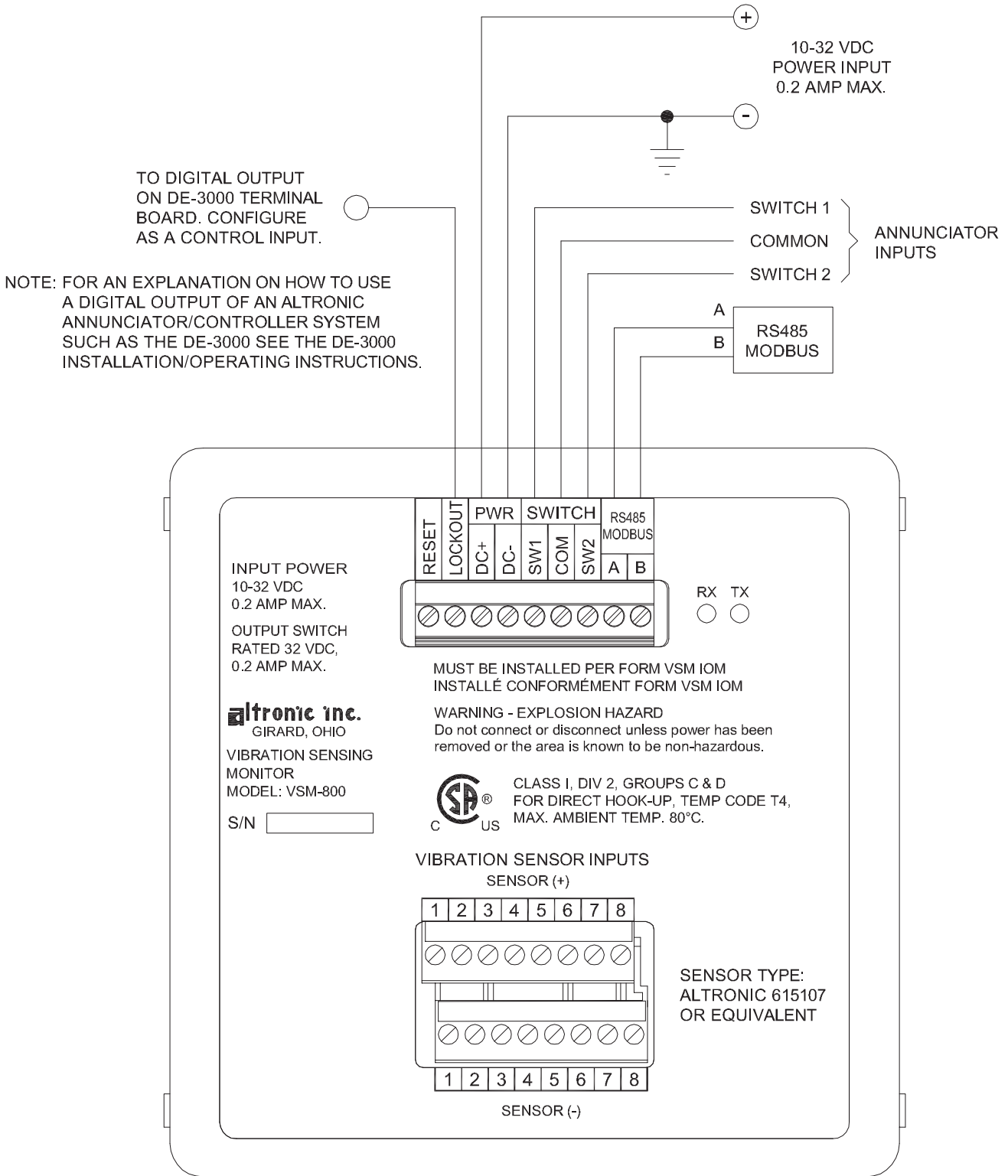
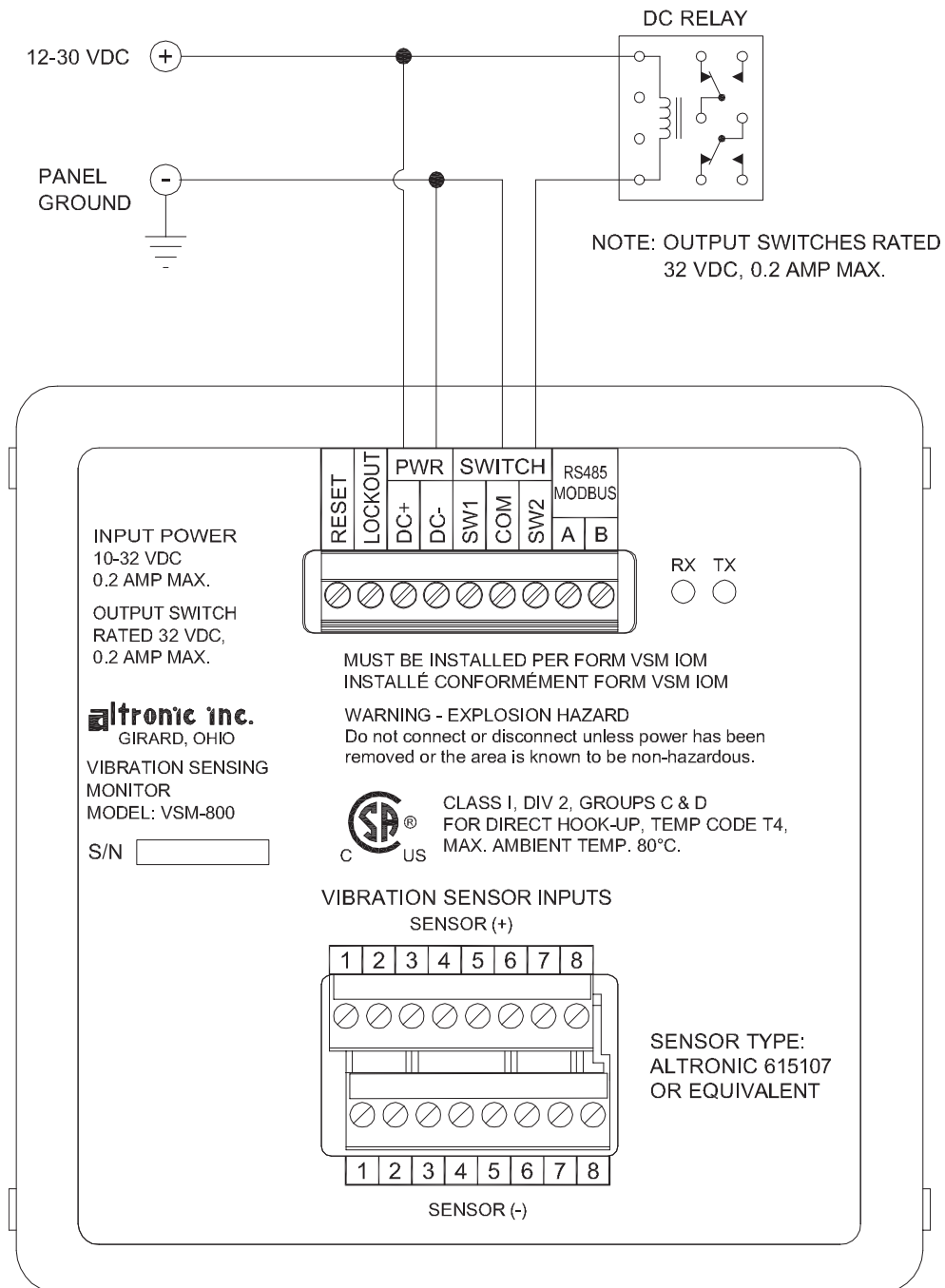

FIGURE 7. WIRING DIAGRAM – DC RELAYS



VSM-400/VSM-800 VIBRATION MONITOR

FIGURE 8. WIRING DIAGRAM – RS485 COMMUNICATIONS, PC HOOK-UP

